

**A** S620-REG2D1W/90 VABRES

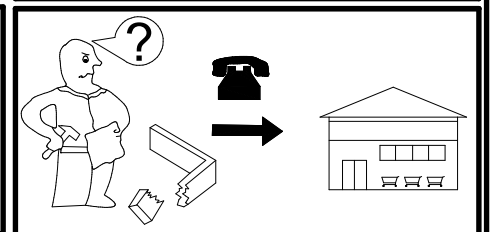

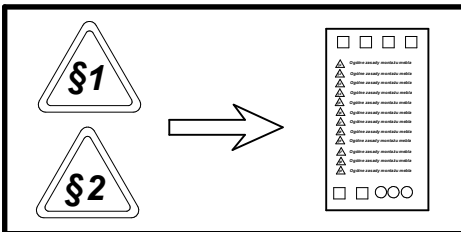

A	B1	B2	C1	C2	C3	D
1	S620-0014	-5	600	496	16	1/3
2	S620-0015	-5	200	496	16	1/3
3	S620-0016	-6	200	496	16	1/3
4	S620-0017	-5	1888	196	16	3/3
5	S620-1014	-6	1896	382	16	3/3
6	S620-1015	-5	1896	382	16	3/3
7	S620-1016	-6	1896	362	16	2/3
8	S620-2008	-6	901	400	18	2/3
9	S620-2019	-2	901	400	18	2/3
10	S620-3006	-6	466	358	16	1/3
11	S620-3008	-8	465	340	16	1/3
12	S620-3009	-5	385	346	16	1/3
13	S620-3021	-5	384	340	16	1/3
14	S620-5002	-7	464	343	4	1/3
15	S620-5003	-5	932	461	4	1/3
16	S620-5060	-6	1888	22	16	3/3
17	S620-7005	-6	1888	250	16	3/3
18	S620-9007	-5	1906	398	2,5	2/3
19	S620-9305	-5	1906	479	2,5	2/3

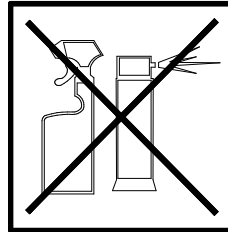
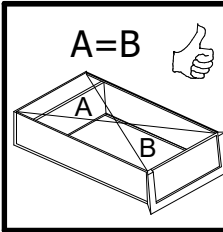
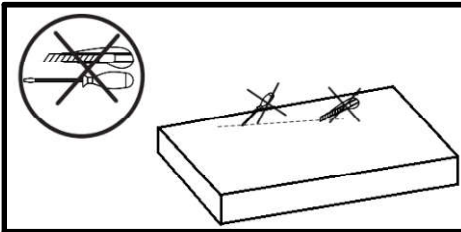
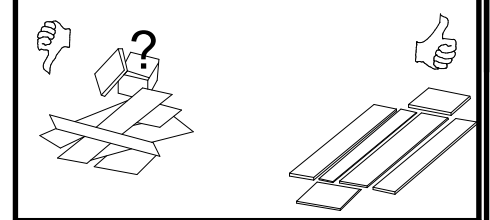
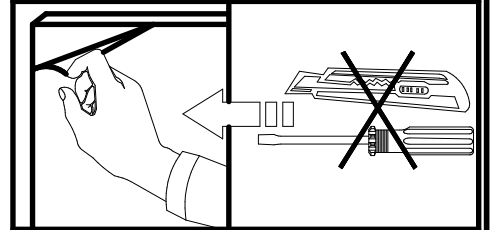
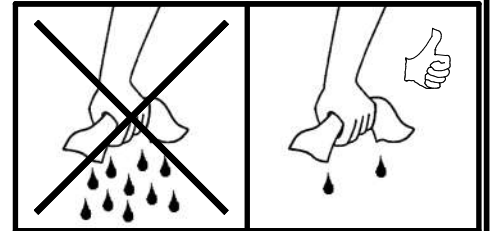
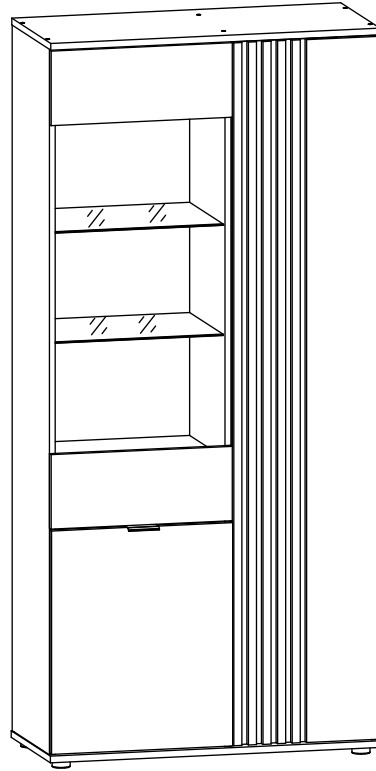
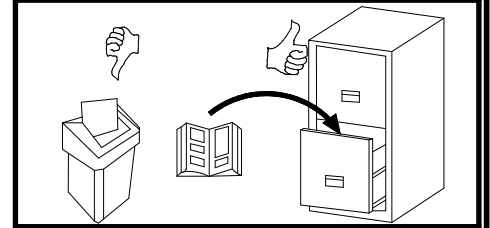
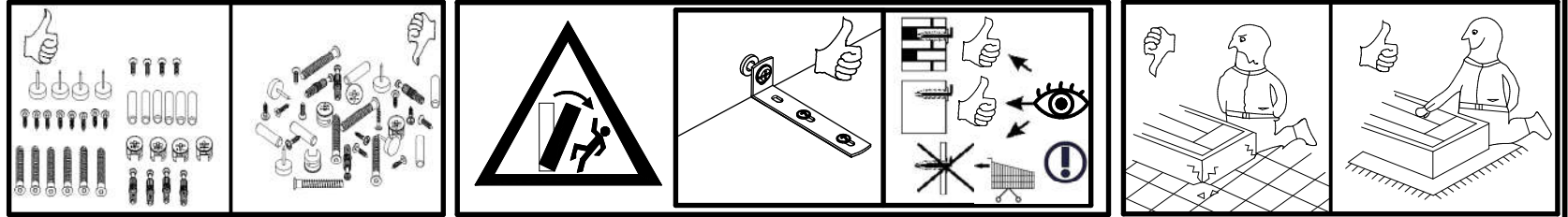
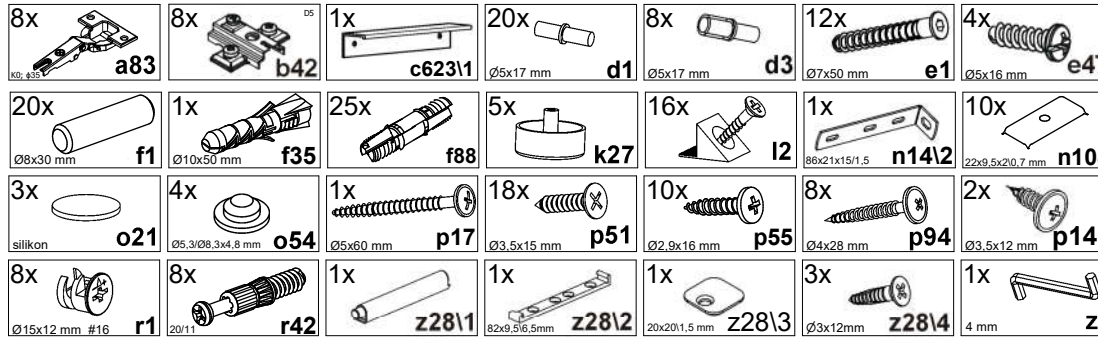
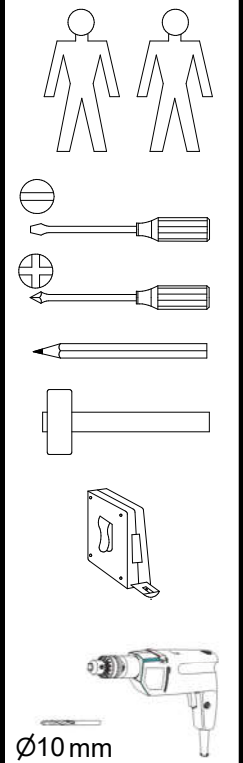

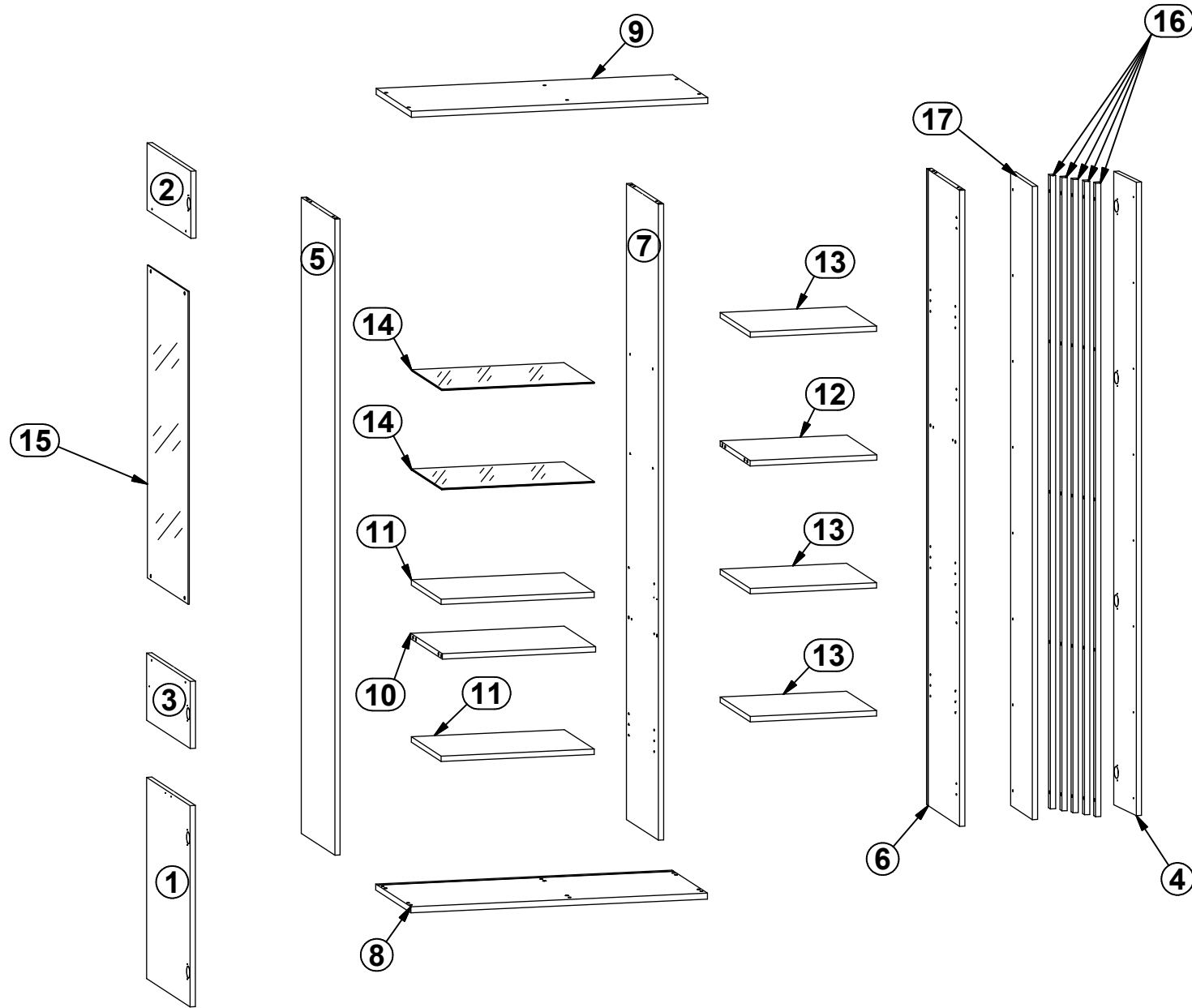

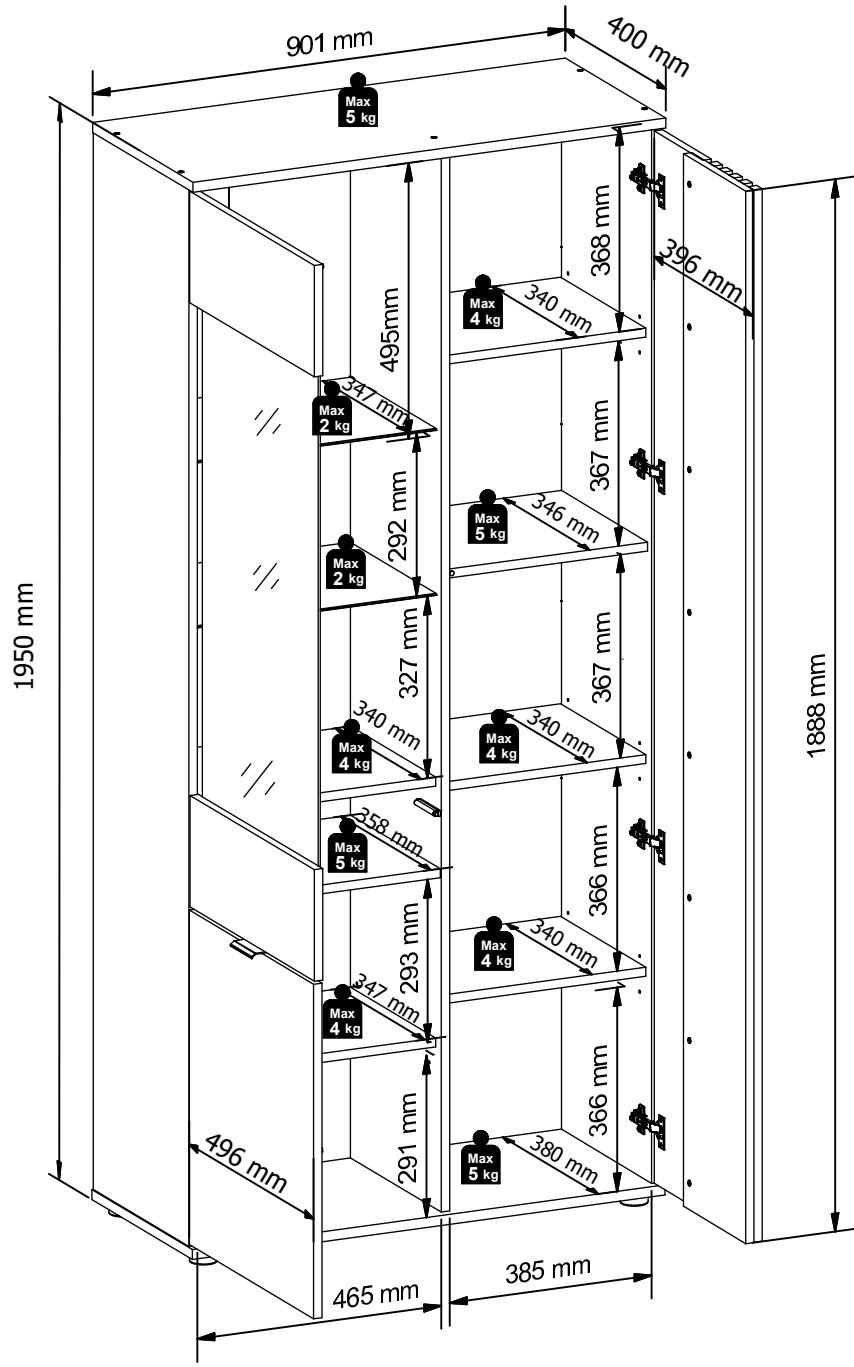

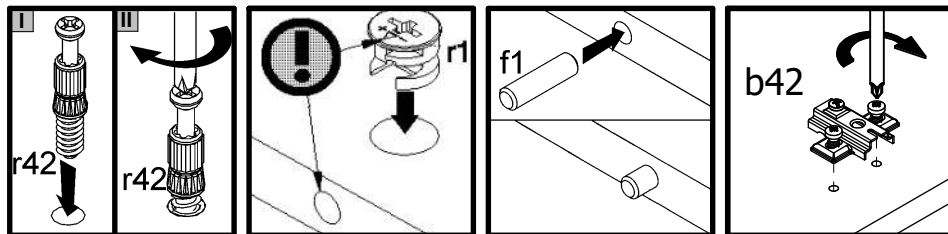
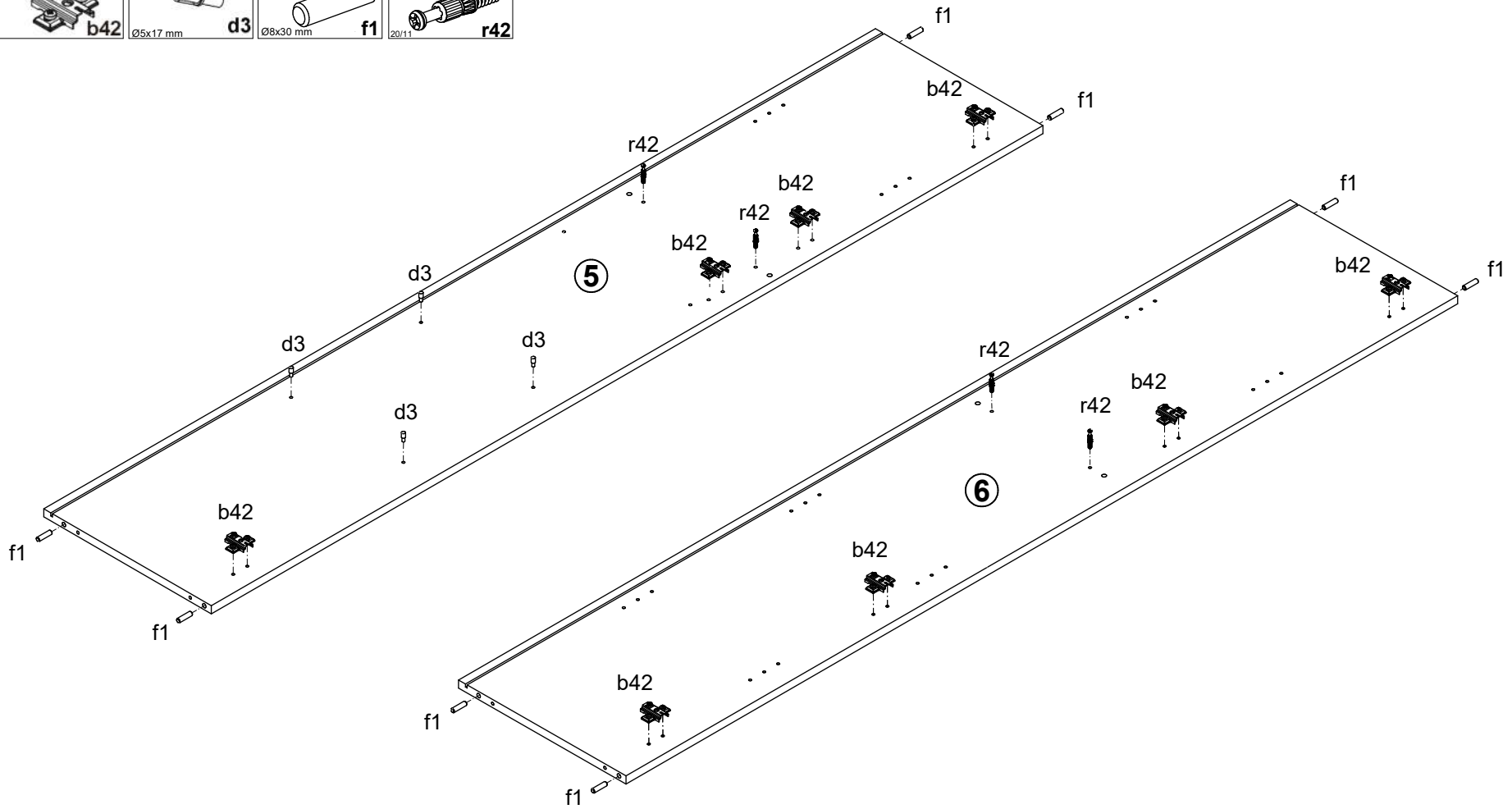
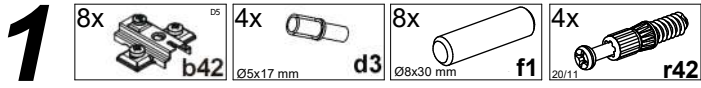





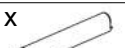

2

- 4x   $\varnothing 5 \times 17 \text{ mm}$  d3
- 4x   $\varnothing 8 \times 30 \text{ mm}$  f1
- 4x  20/11 r42
- 1x   $82 \times 9,516,5 \text{ mm}$  z28\2
- 1x  z28\1
- 2x   $\varnothing 3 \times 12 \text{ mm}$  z28\4

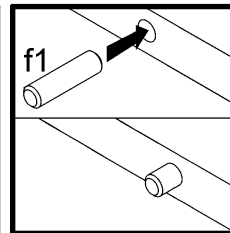
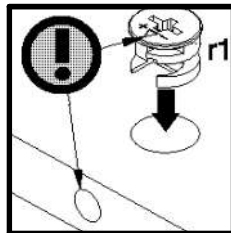
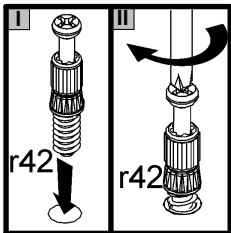
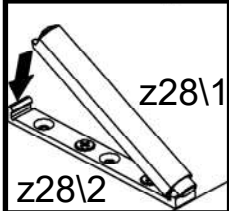
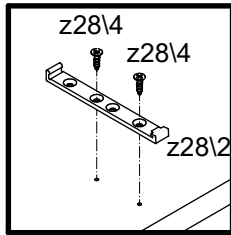
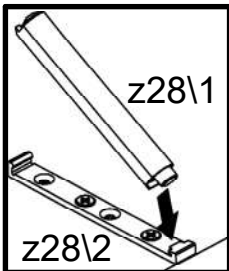
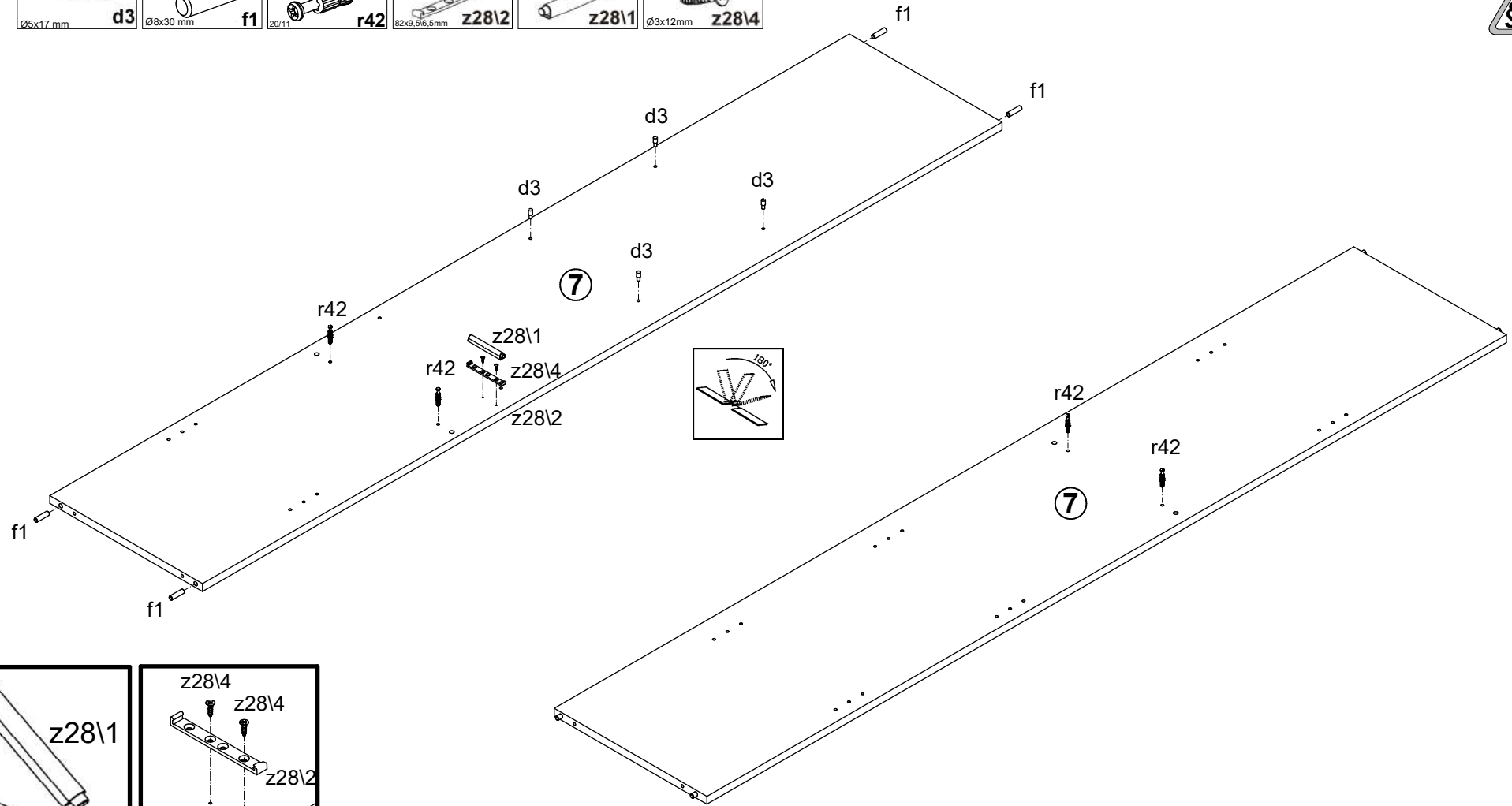

3

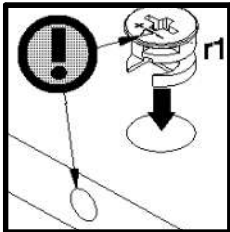
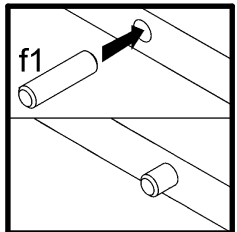
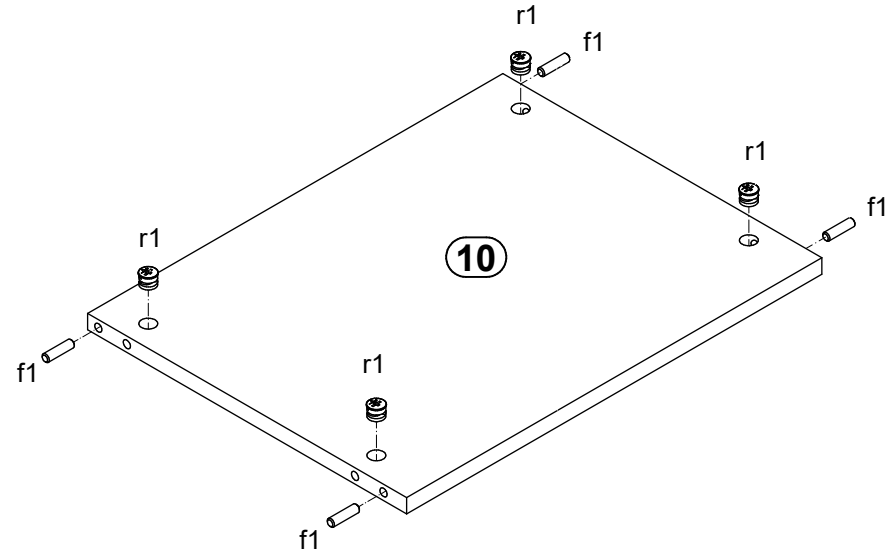
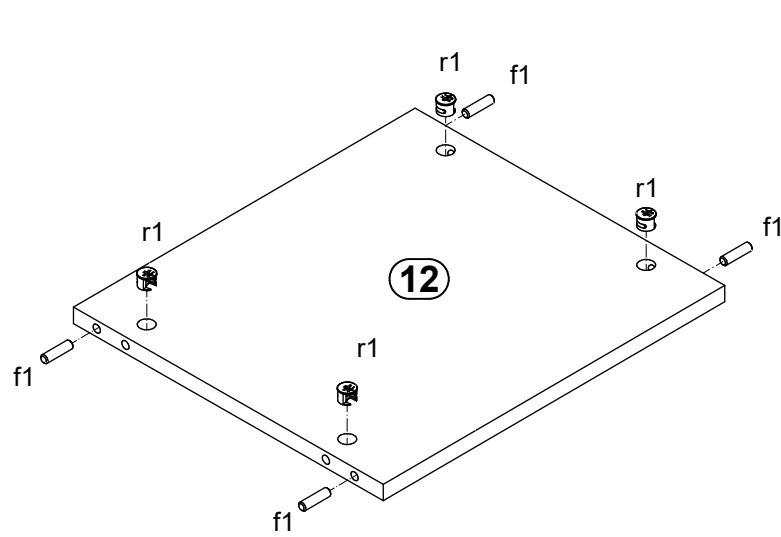
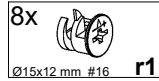
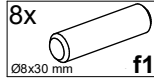

4

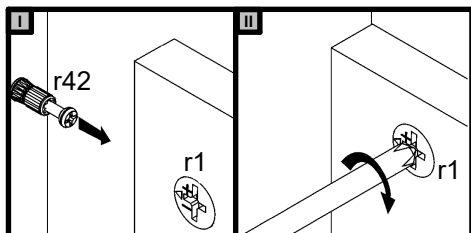
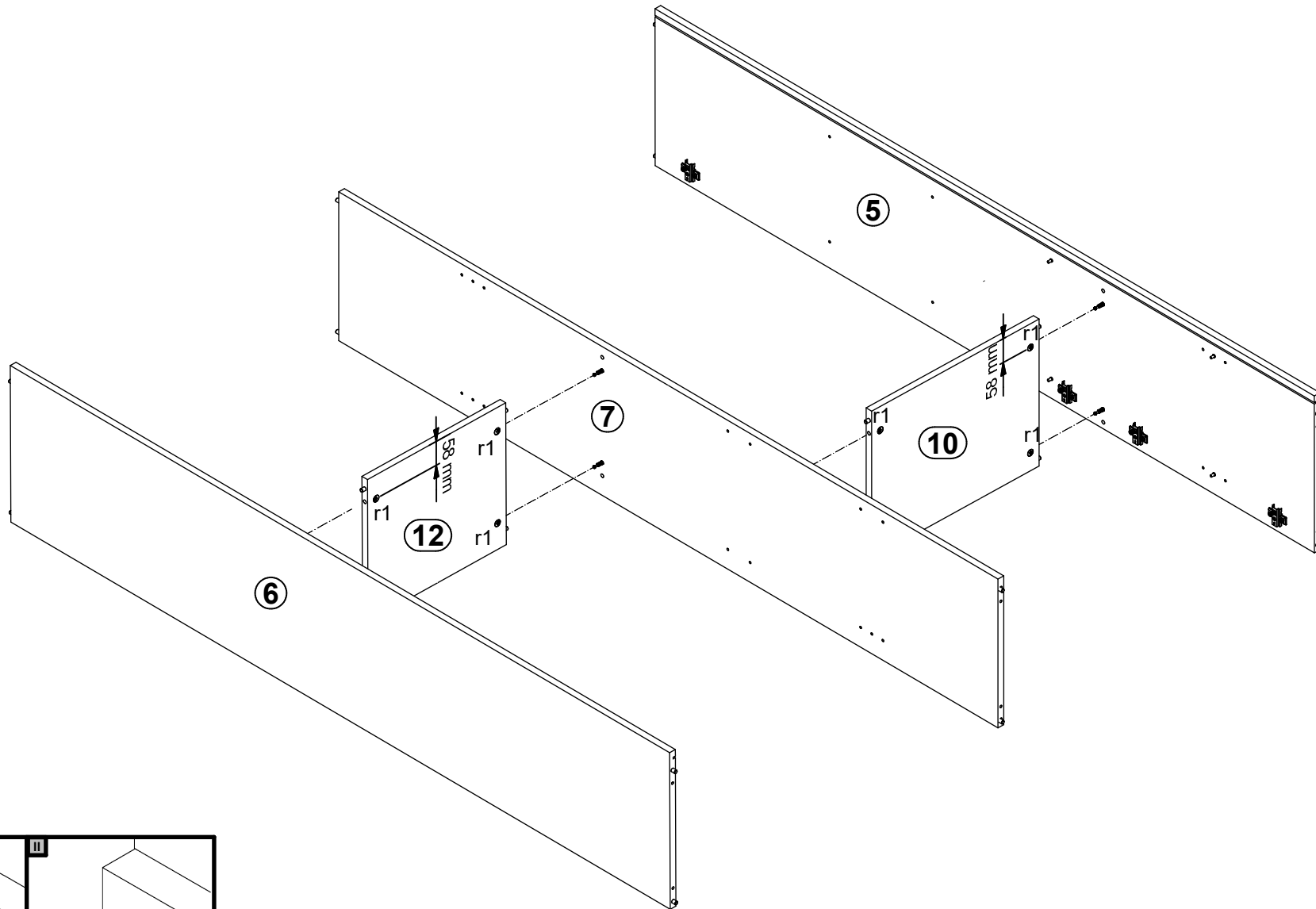



5

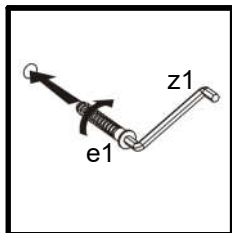
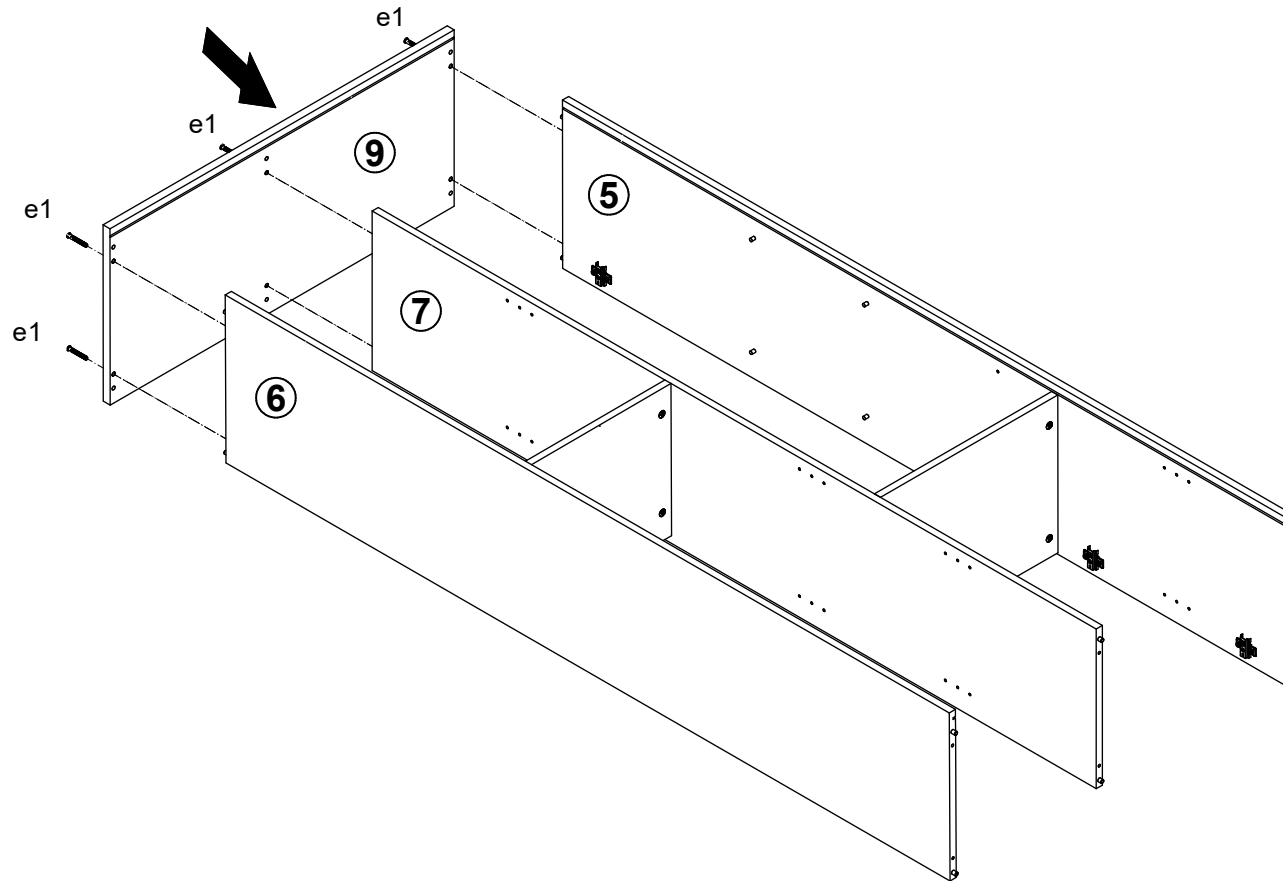
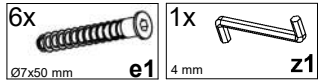



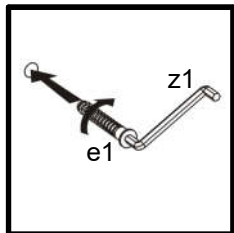
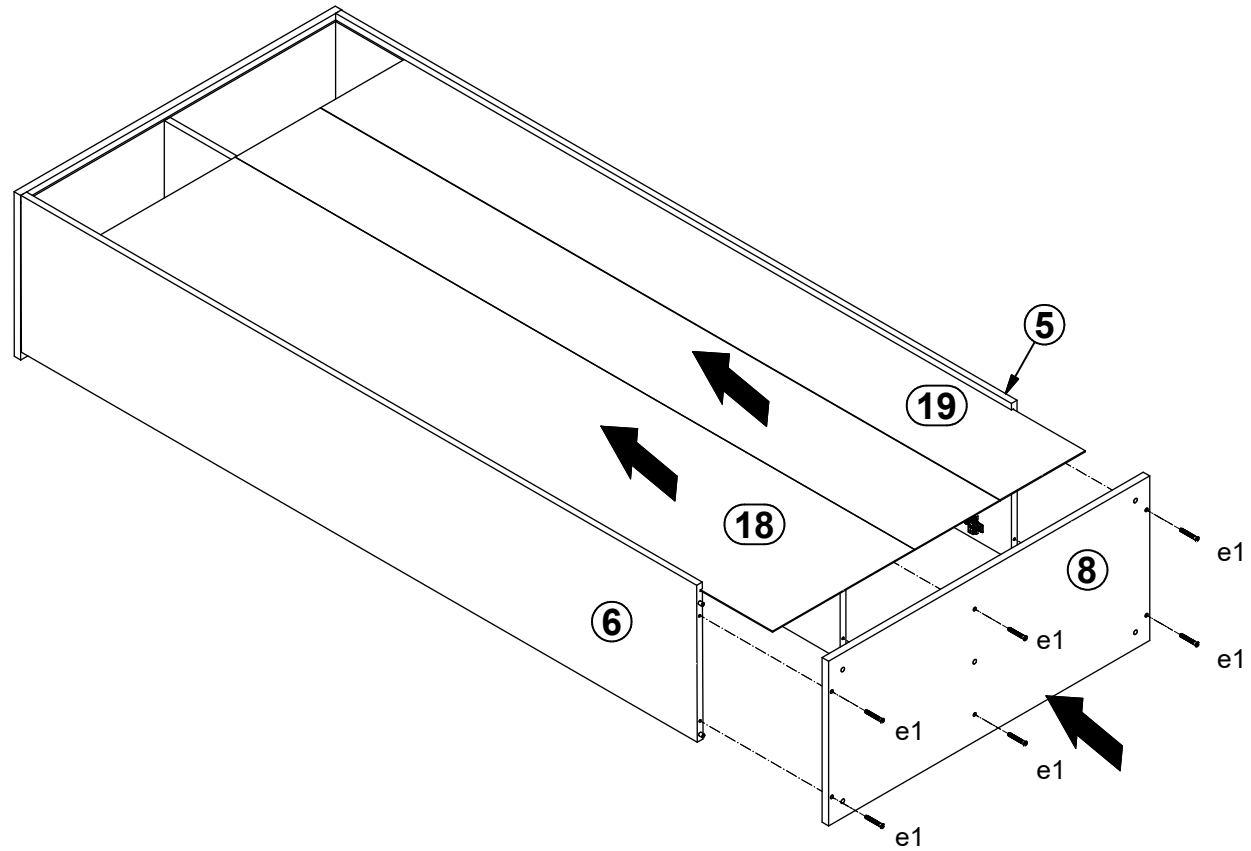
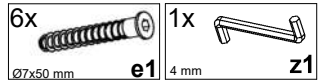

6

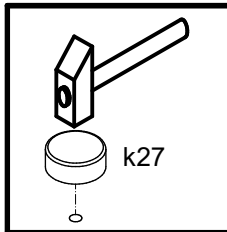
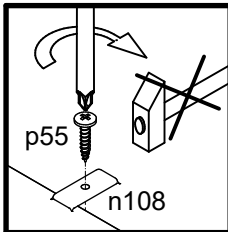
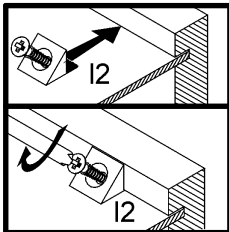
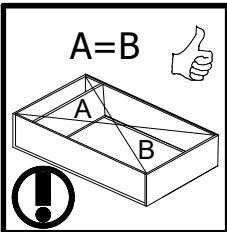
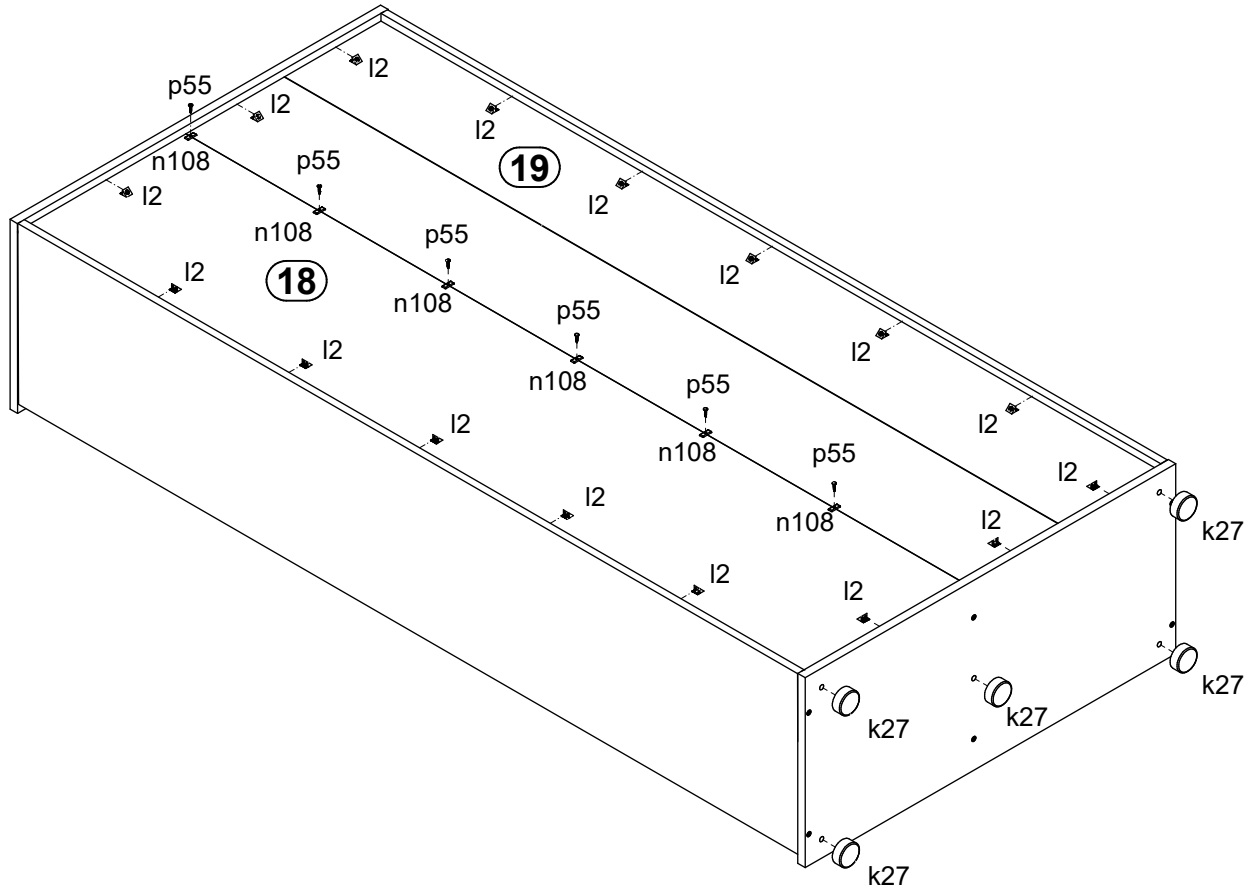
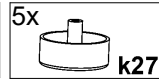
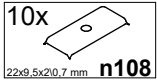
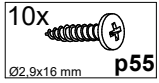
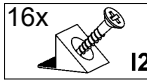

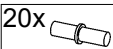
7

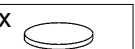

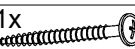
- 8 20x  d1  $\varnothing 5 \times 17 \text{ mm}$
- 1x  n14\2  $86 \times 21 \times 15 / 1,5$
- 1x  silikon o21
- 2x  p51  $\varnothing 3,5 \times 15 \text{ mm}$
- 1x  f35  $\varnothing 10 \times 50 \text{ mm}$
- 1x  p17  $\varnothing 5 \times 60 \text{ mm}$

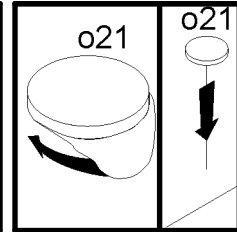
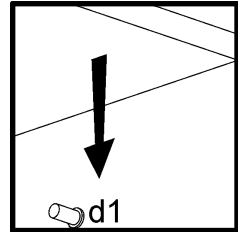
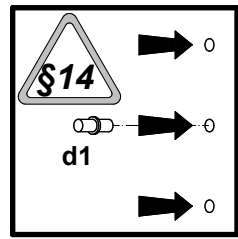
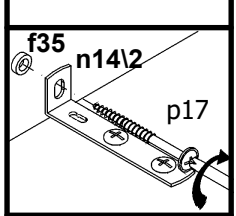
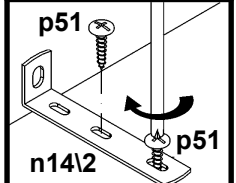
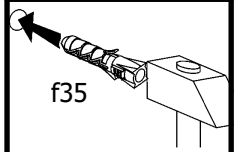
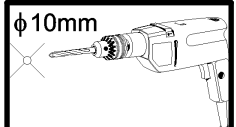
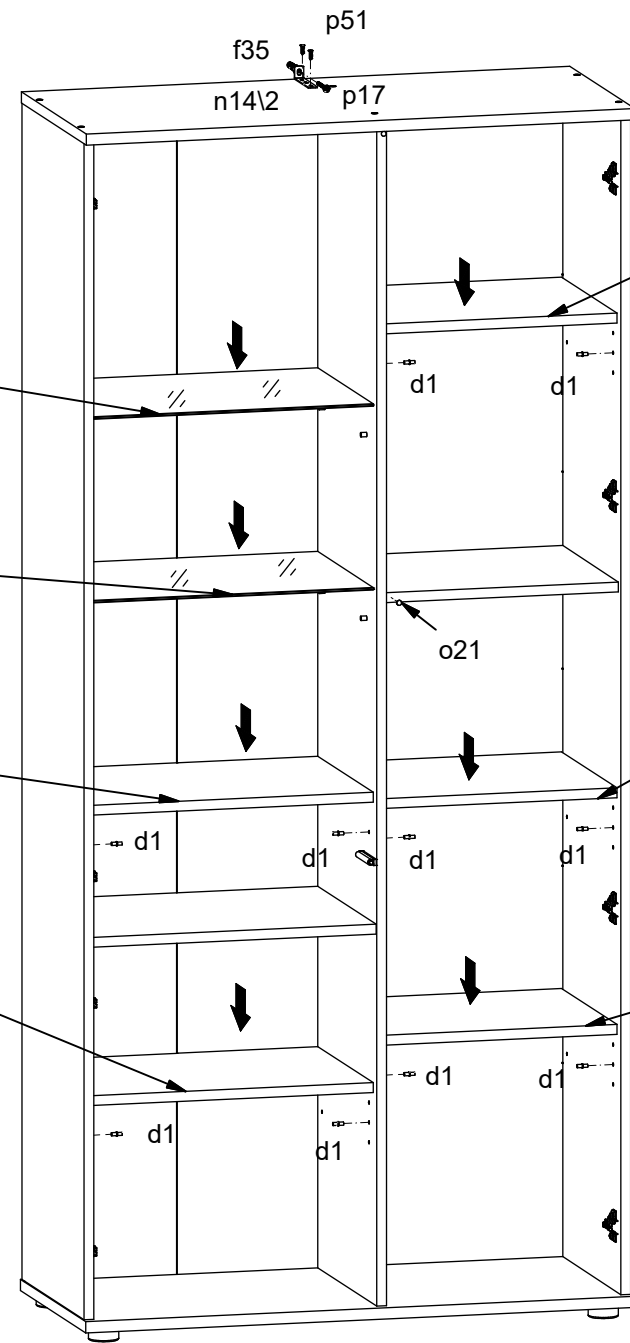

9

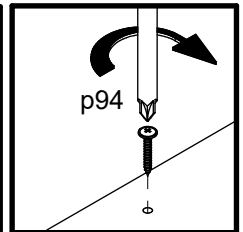
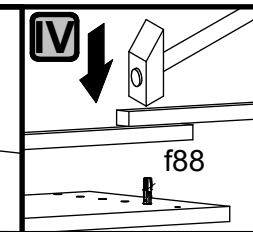
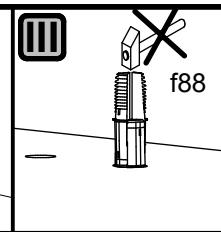
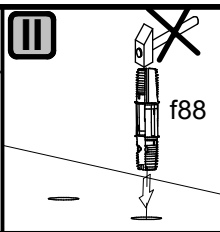
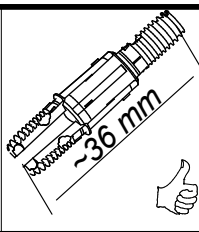
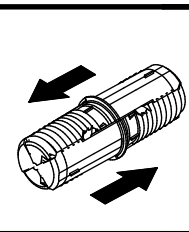
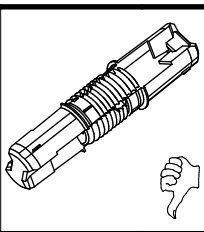
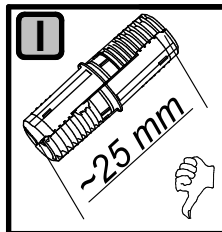
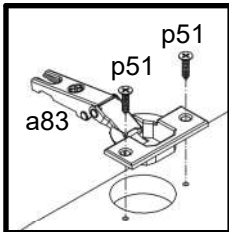
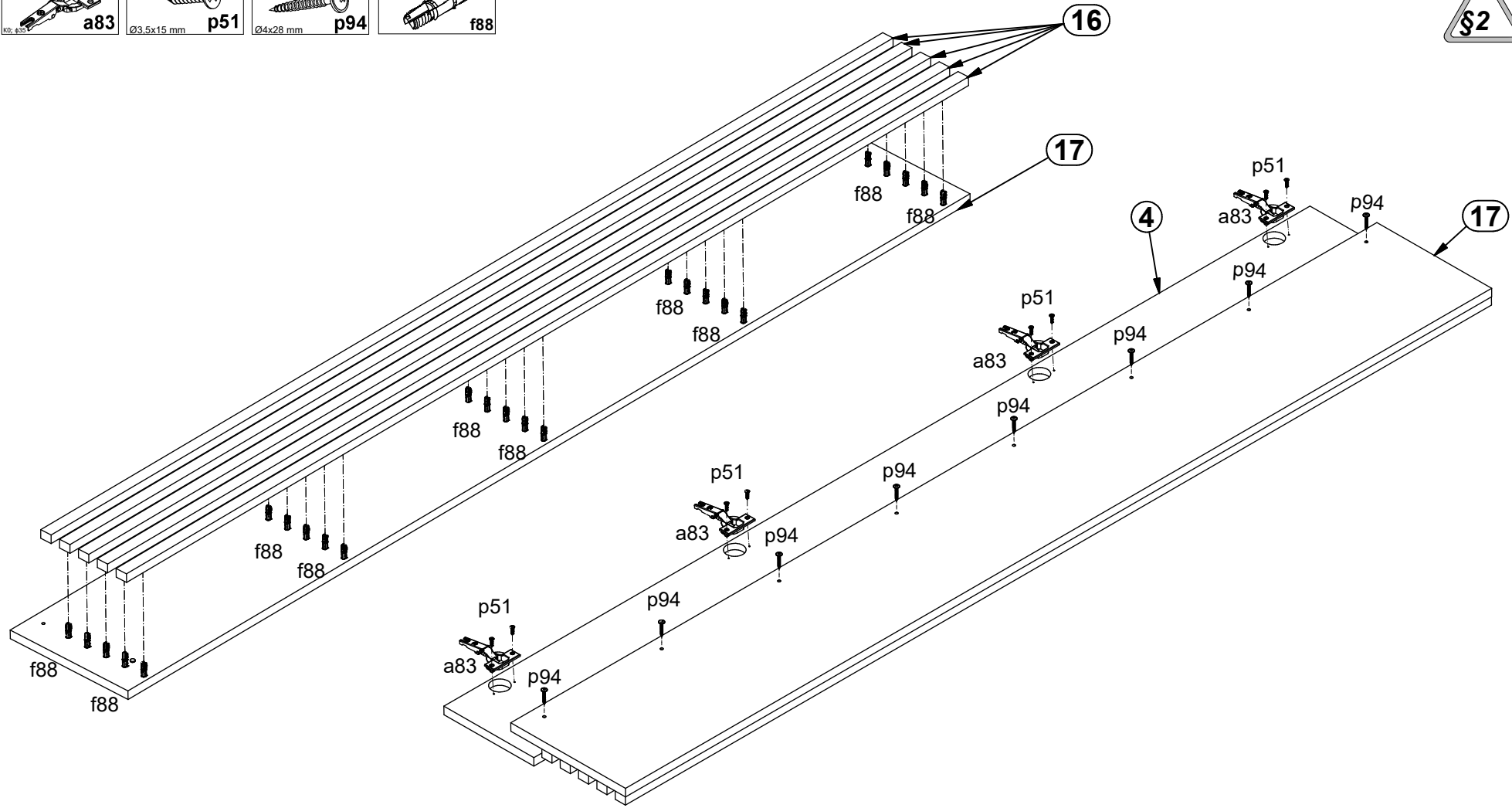
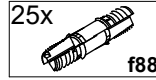
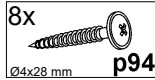
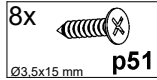
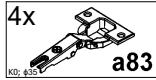

10

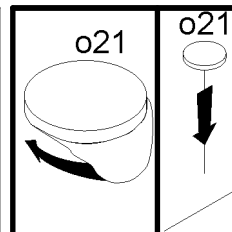
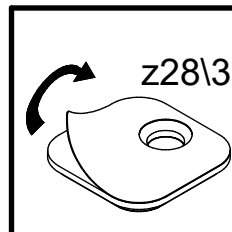
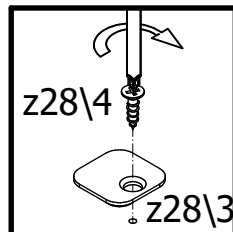
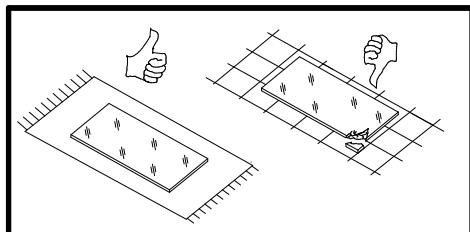
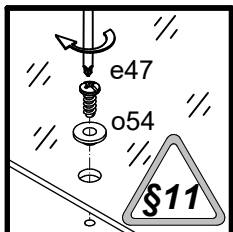
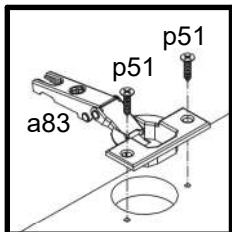
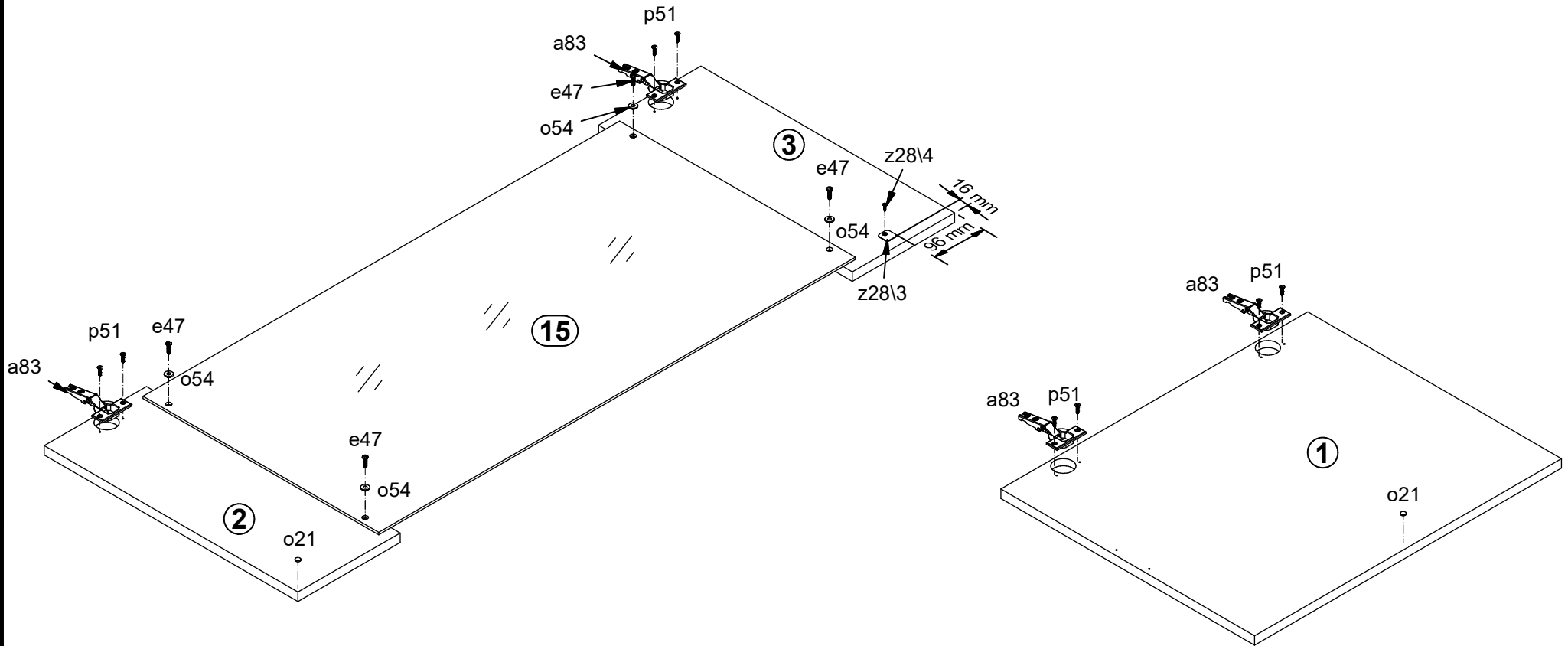
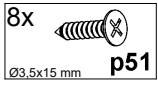
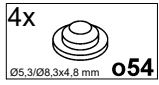
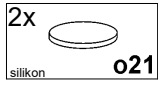
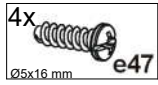
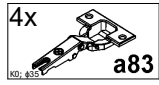

11

