





NR 1	
B1	 ϕ 8x28 x20
C2	 x12
M1	 x12
T1	 x12
F15	 x4
K1	 7x50 x4

PROJEKT 1

P9 -- 60 90

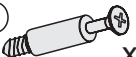
1

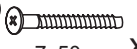
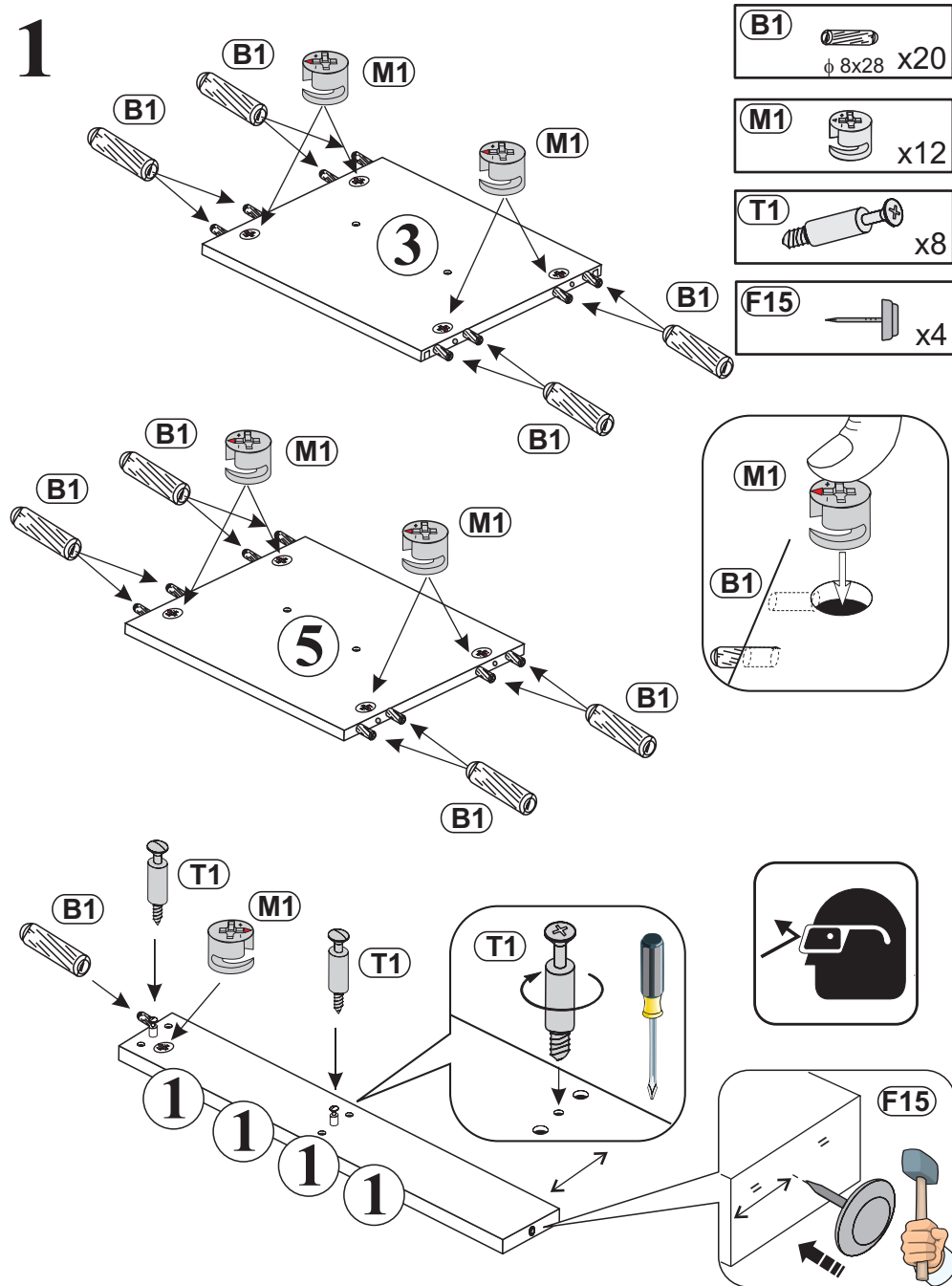

2

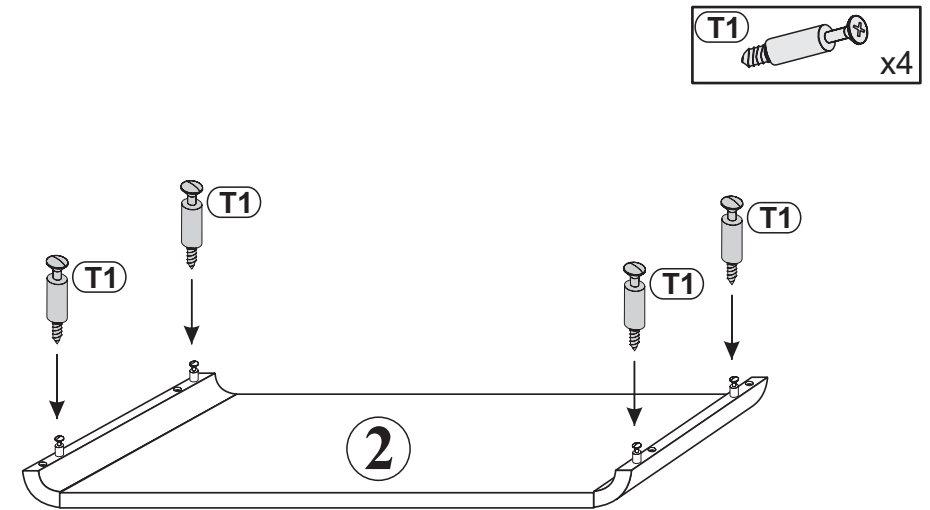

3

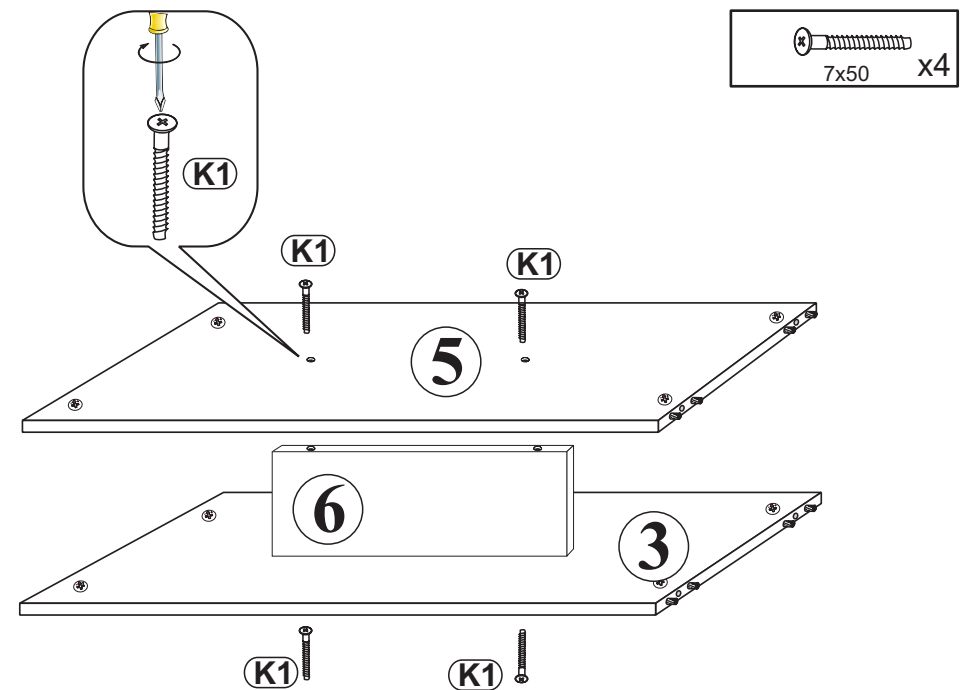

4

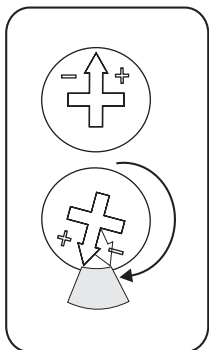
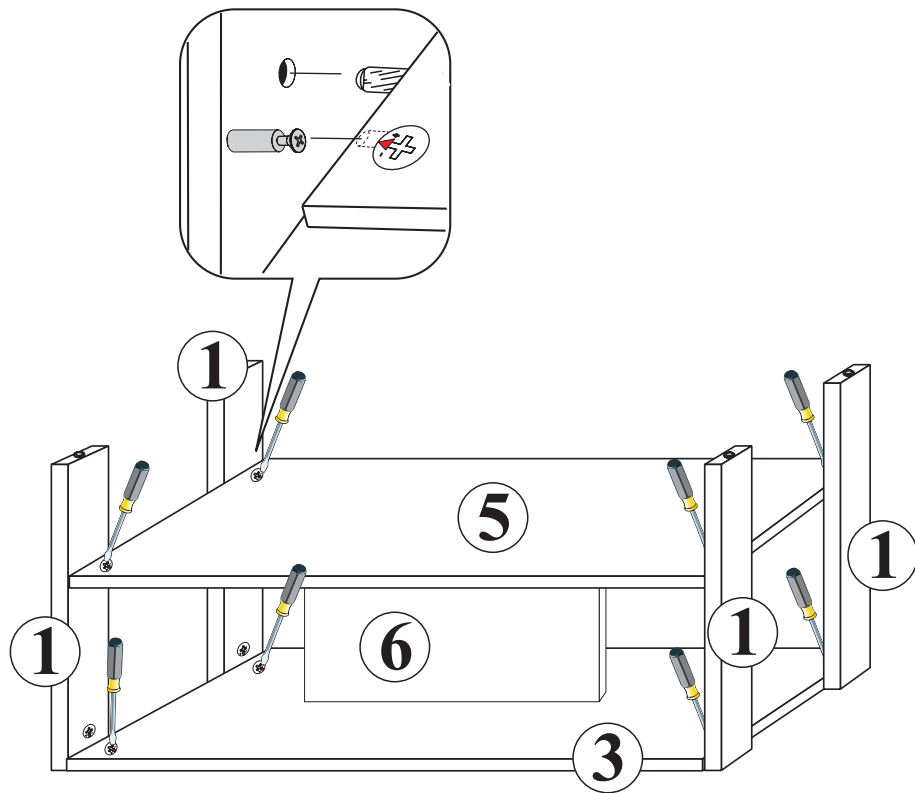

5

C2  x12

