

PORTO 302

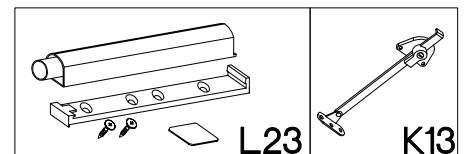
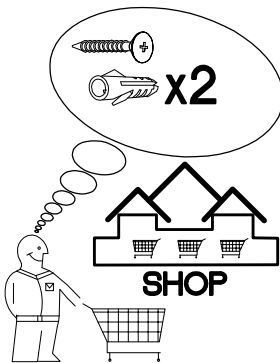
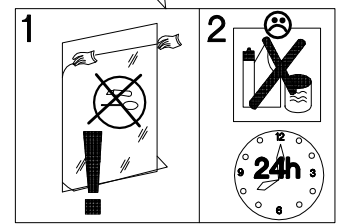
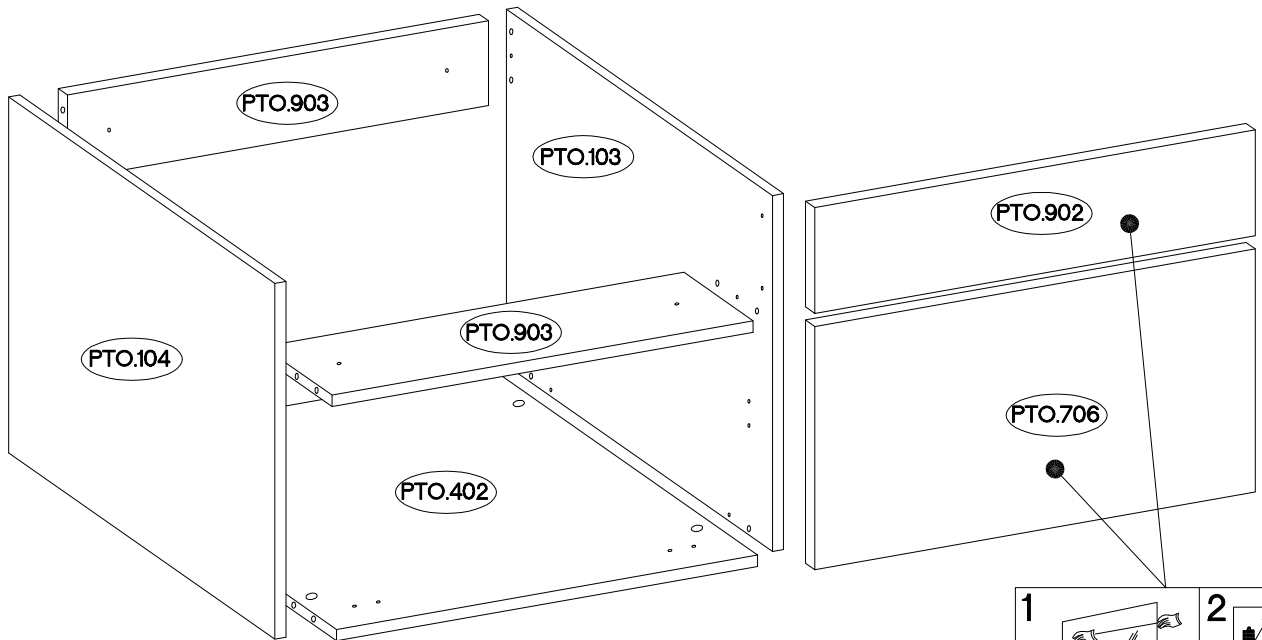
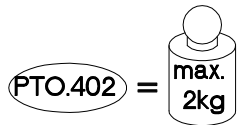
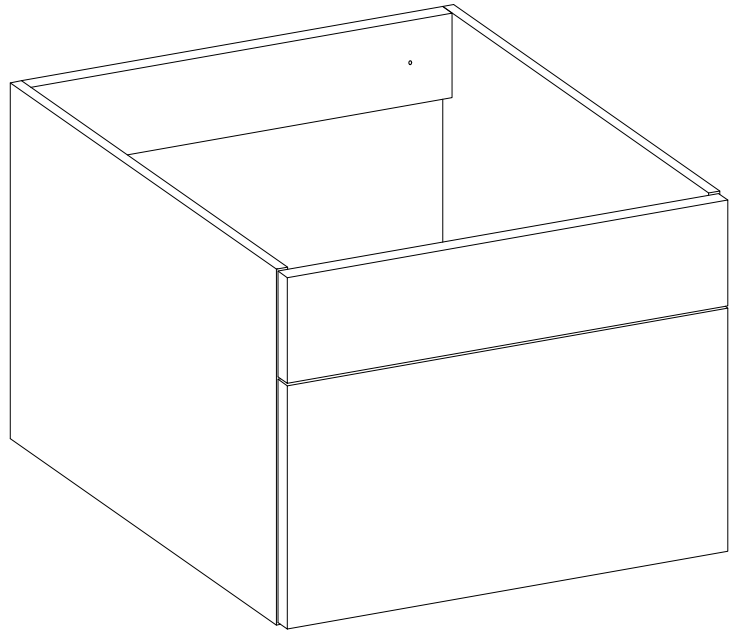

L=20mm D2 8	±15/12mm C 8	±8x30mm A 12	H=0 H 2	±35/0mm G 2	±3.5x13mm P5 7	 E 4	 T3 4	 P1 8	 P11 3
-----------------------	------------------------	------------------------	-------------------	-----------------------	--------------------------	------------	-------------	-------------	--------------

ISM-PTO-002

1

L=20mm	±15/12mm	±8x30mm		±4.0x16mm	
D2	C	A	T3	P1	L23
8	8	12	4	4	1

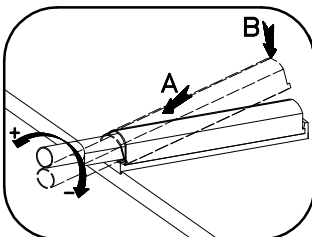
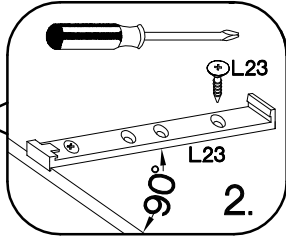
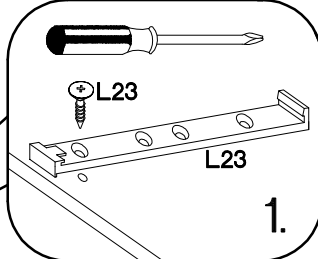
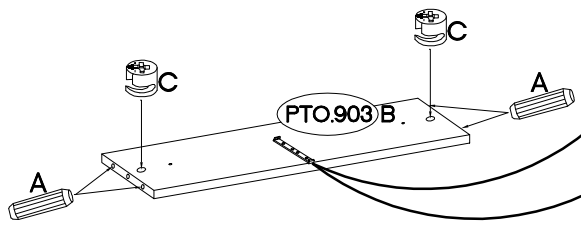
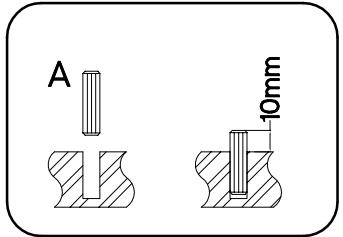
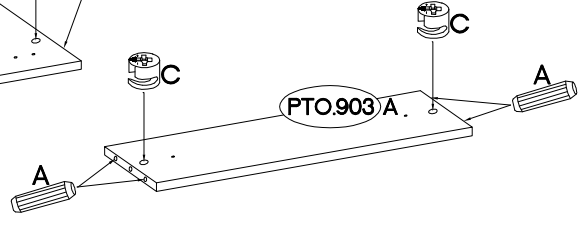
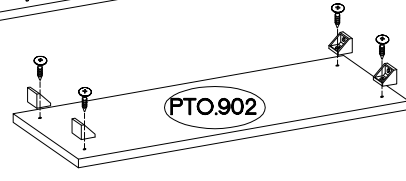
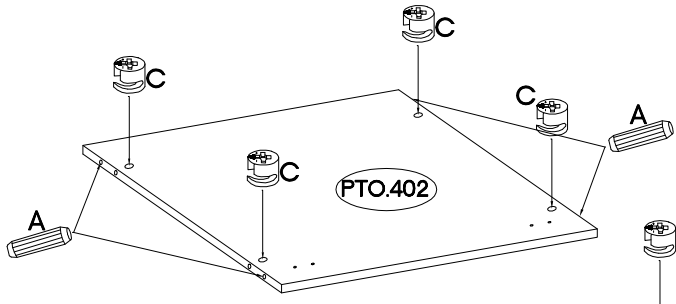
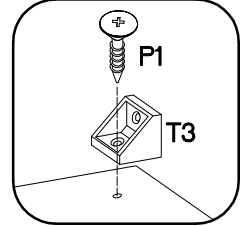
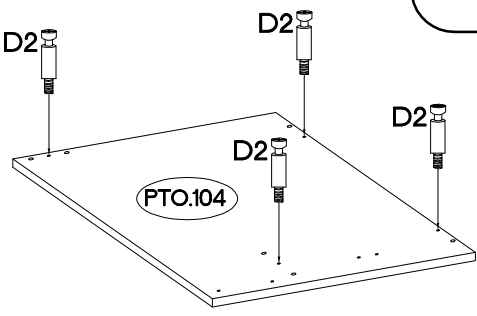
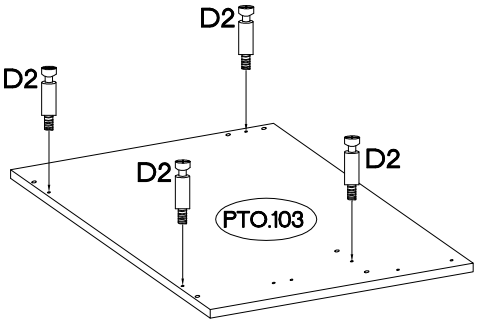
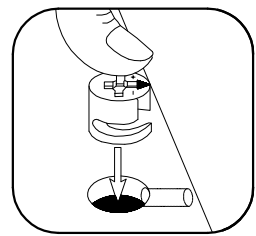
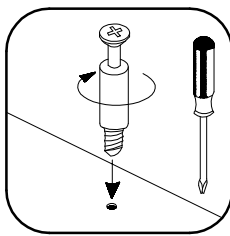

2

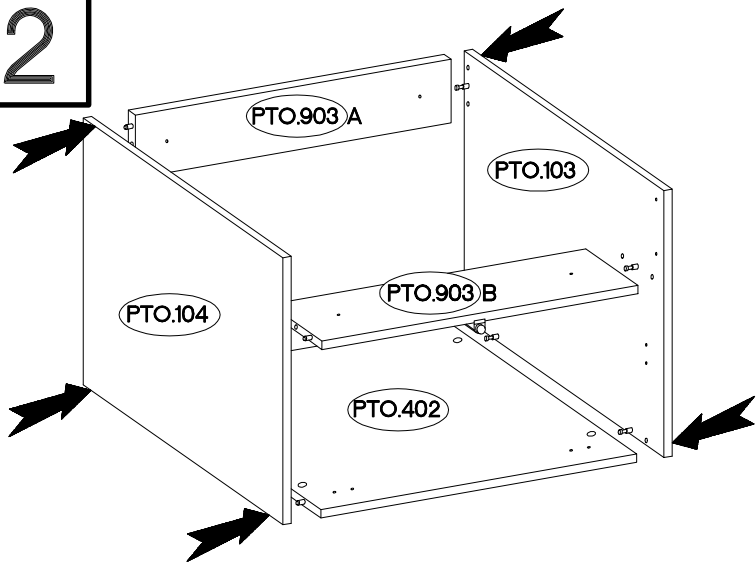

3

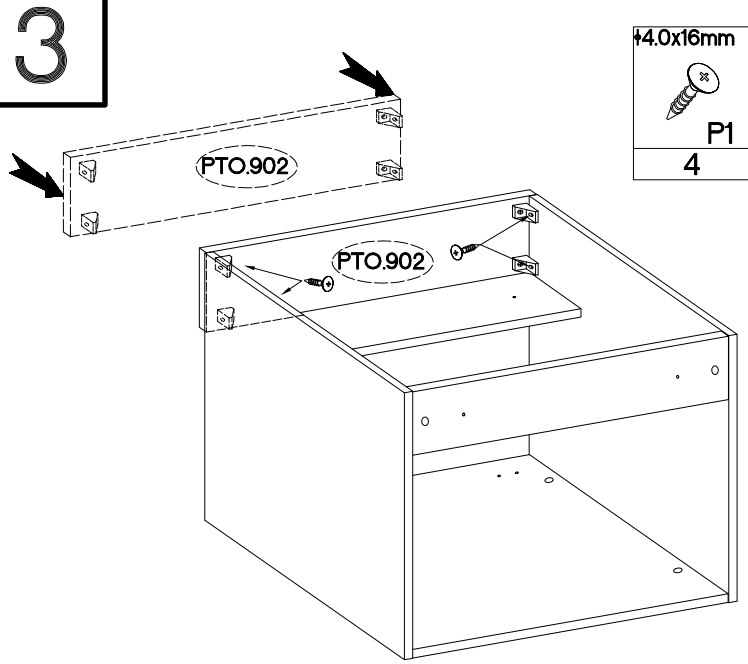

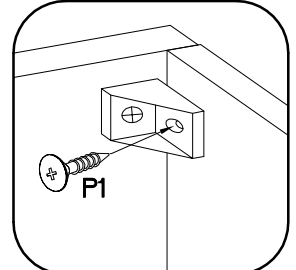
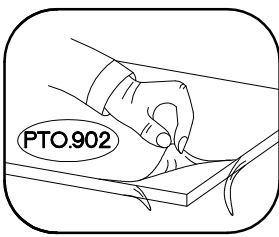
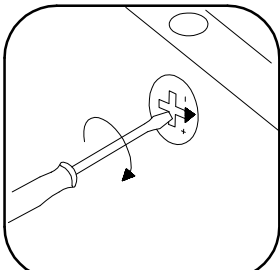
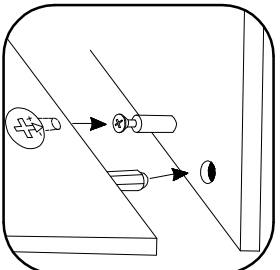

±4.0x16mm
P1
4

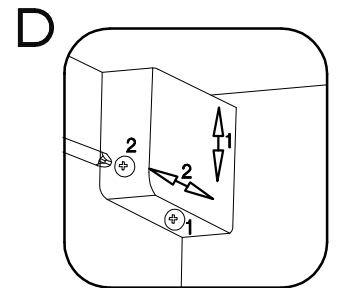
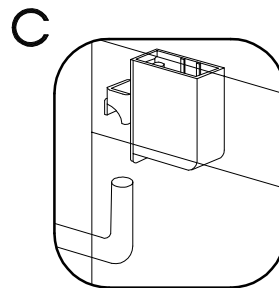
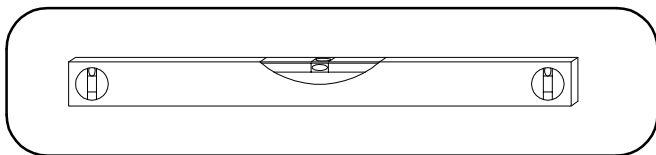
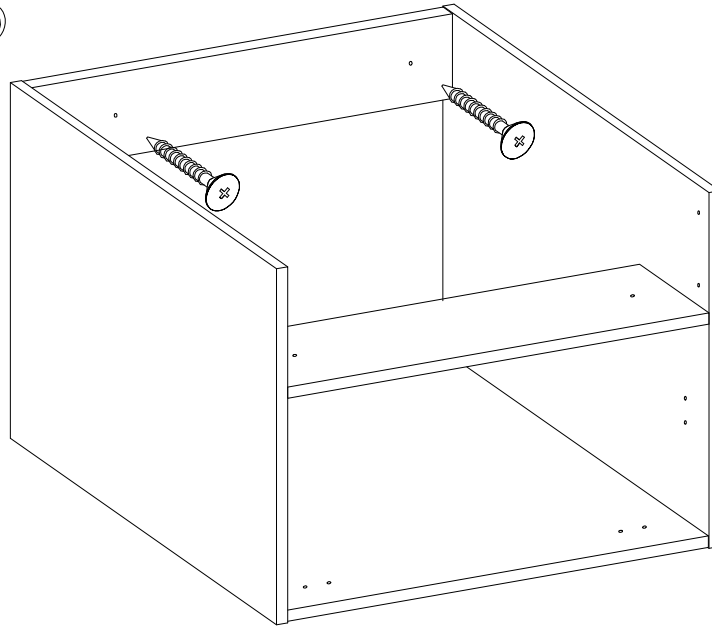
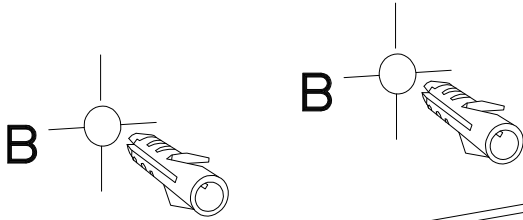
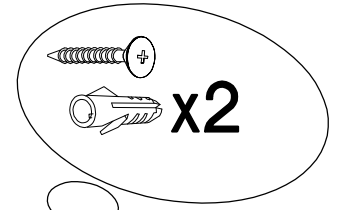
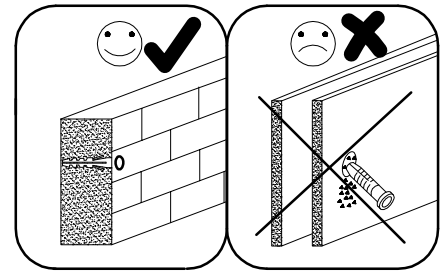
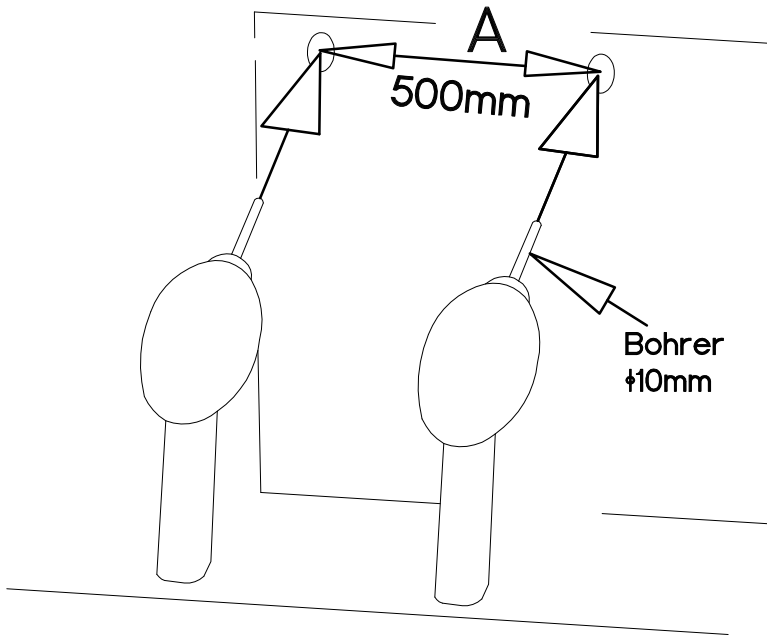



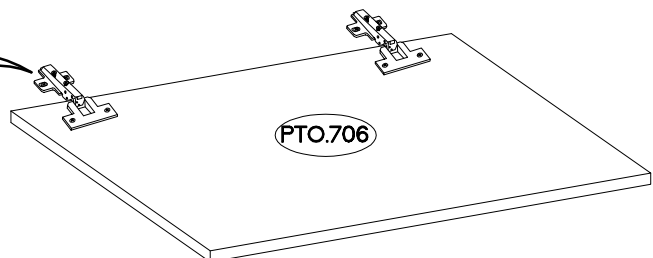
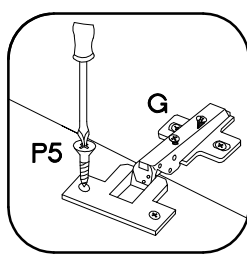
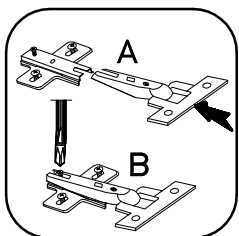

5

	±35/0mm
G	
2	
	±3.5x13mm
H	
2	
	P5
4	

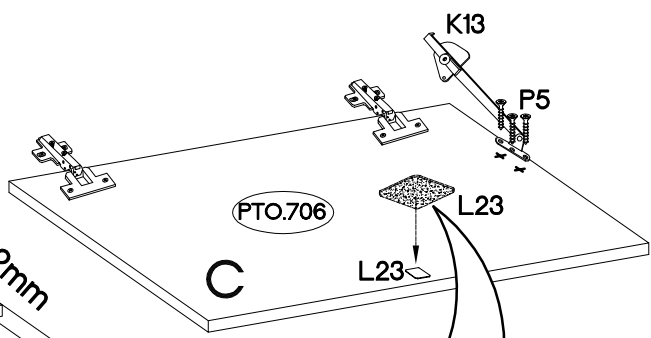
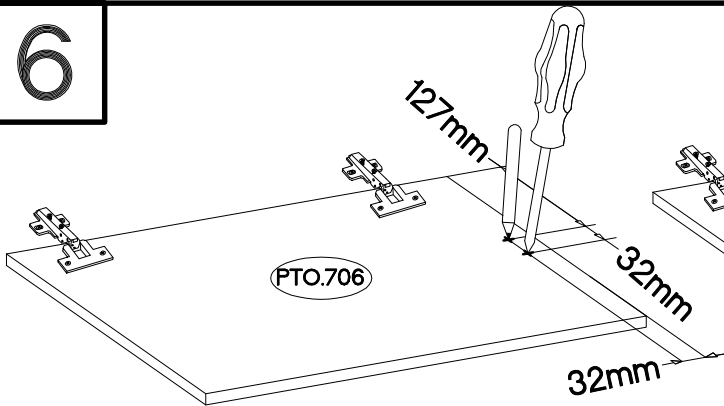

6

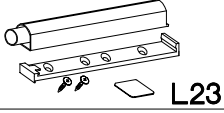

	±3.5x13mm
K13	
1	
	P5
3	
	L23
1	

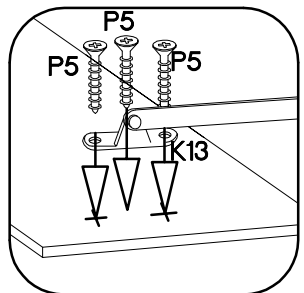
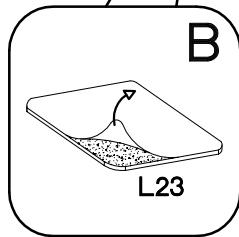
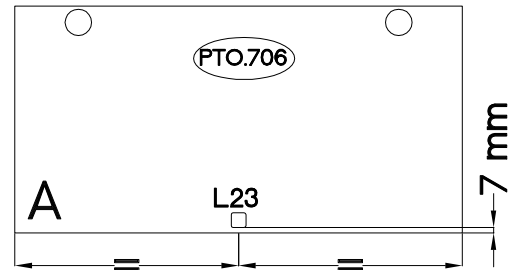
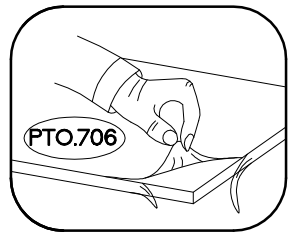

7

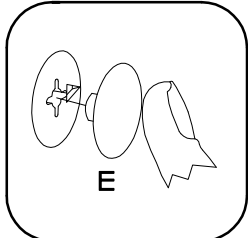
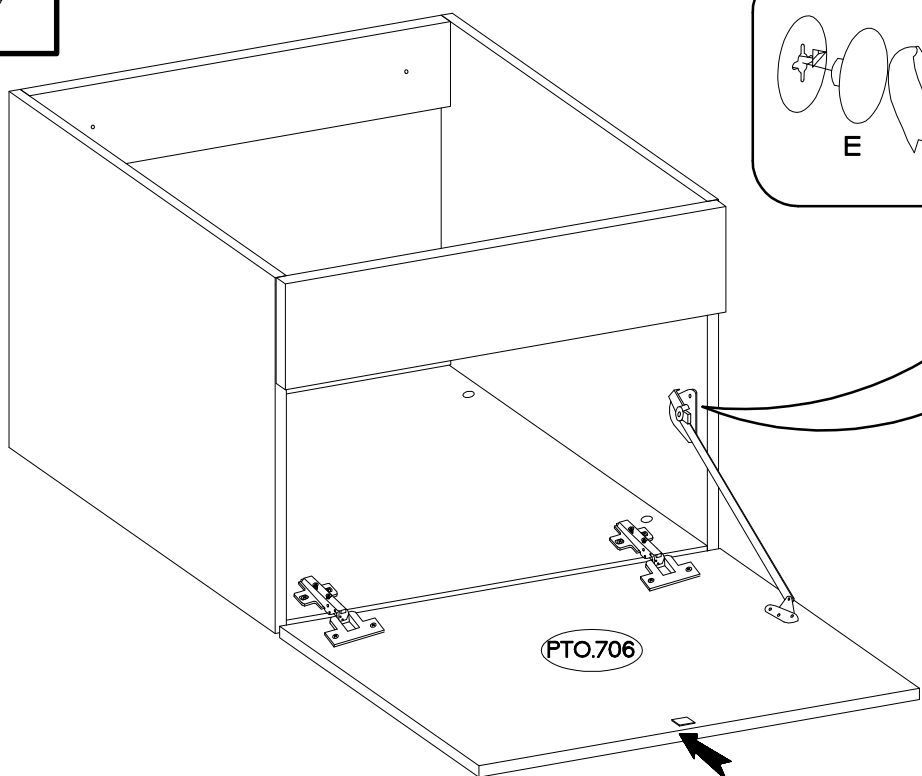

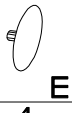
	±3.0x16mm
P11	
3	
	E
4	

