

A	B	C	D	A	B	C	D		
1	HM1-014	465	344	1/1	6	HM1-318	471	339	1/1
2	HM1-123	1248	340	1/1	7	HM1-319	471	320	1/1
3	HM1-128	1248	340	1/1	8	HM1-446	471	32	1/1
4	HM1-205	555	350	1/1	9	HM1-912	1148	265	1/1
5	HM1-316	471	339	1/1	10	LH-1114	1114	14	1/1

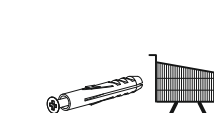

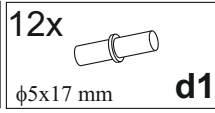

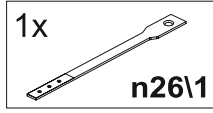
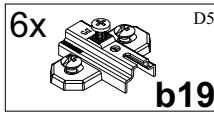
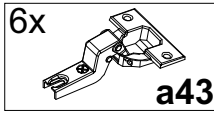
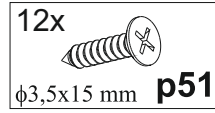
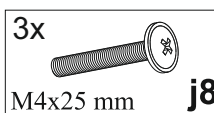
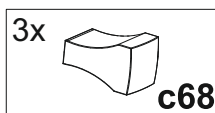
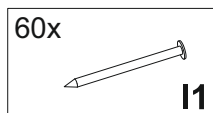
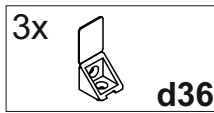
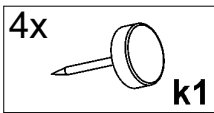
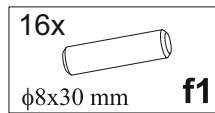
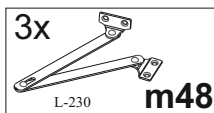
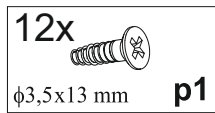
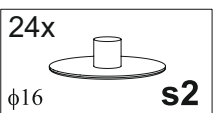
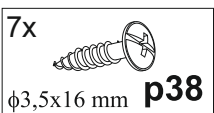
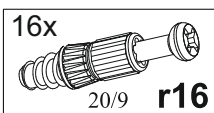
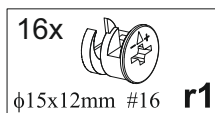
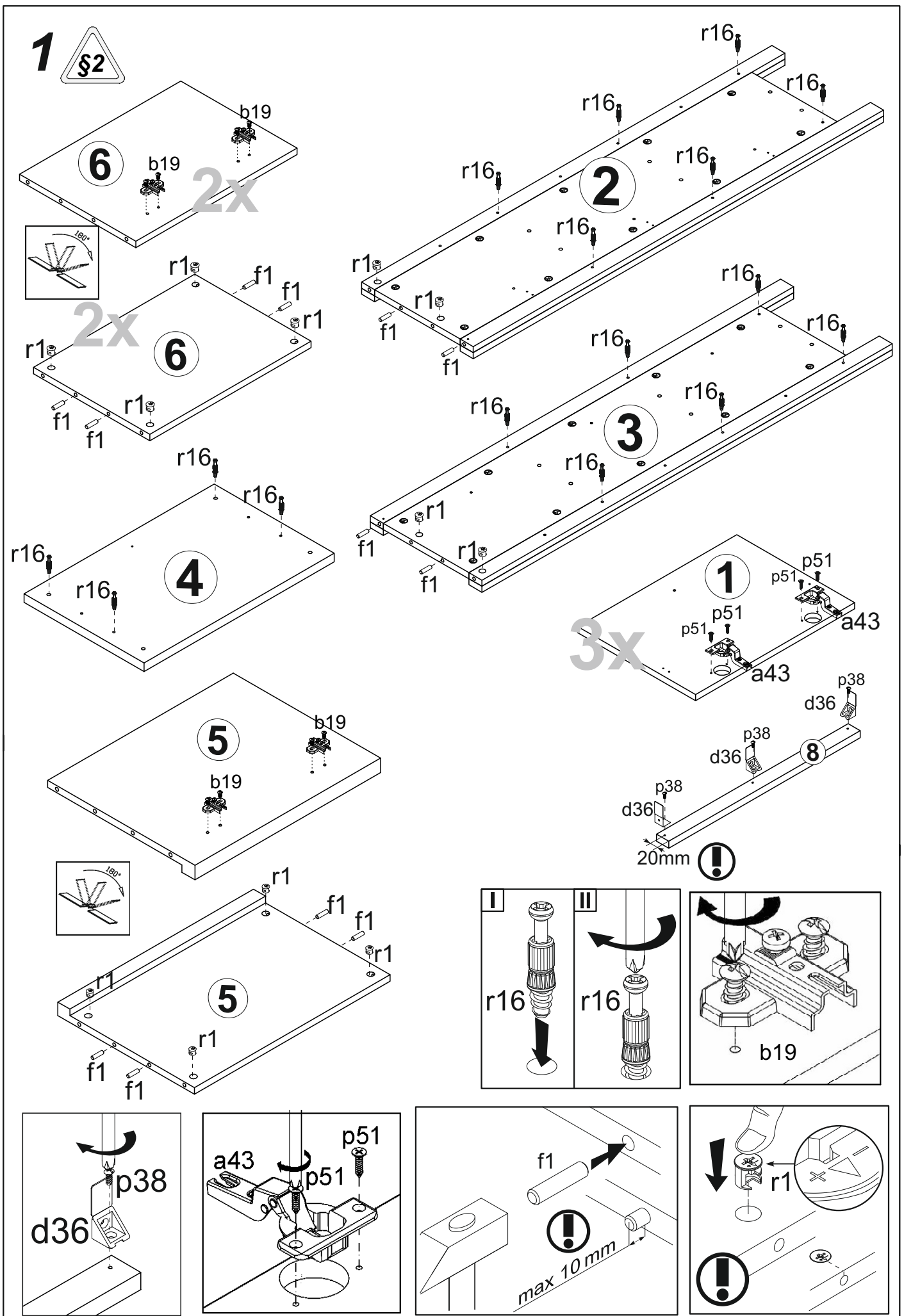
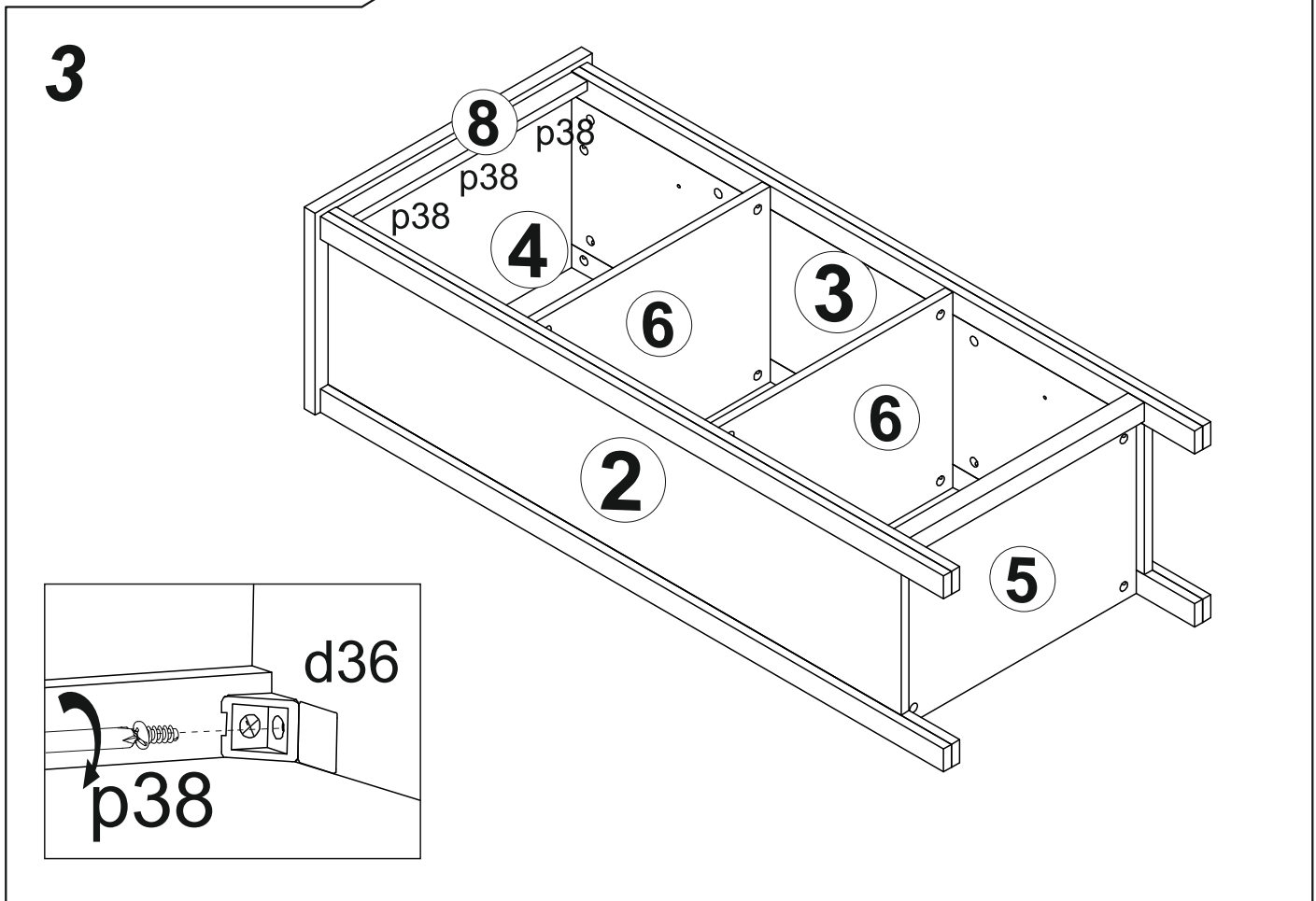
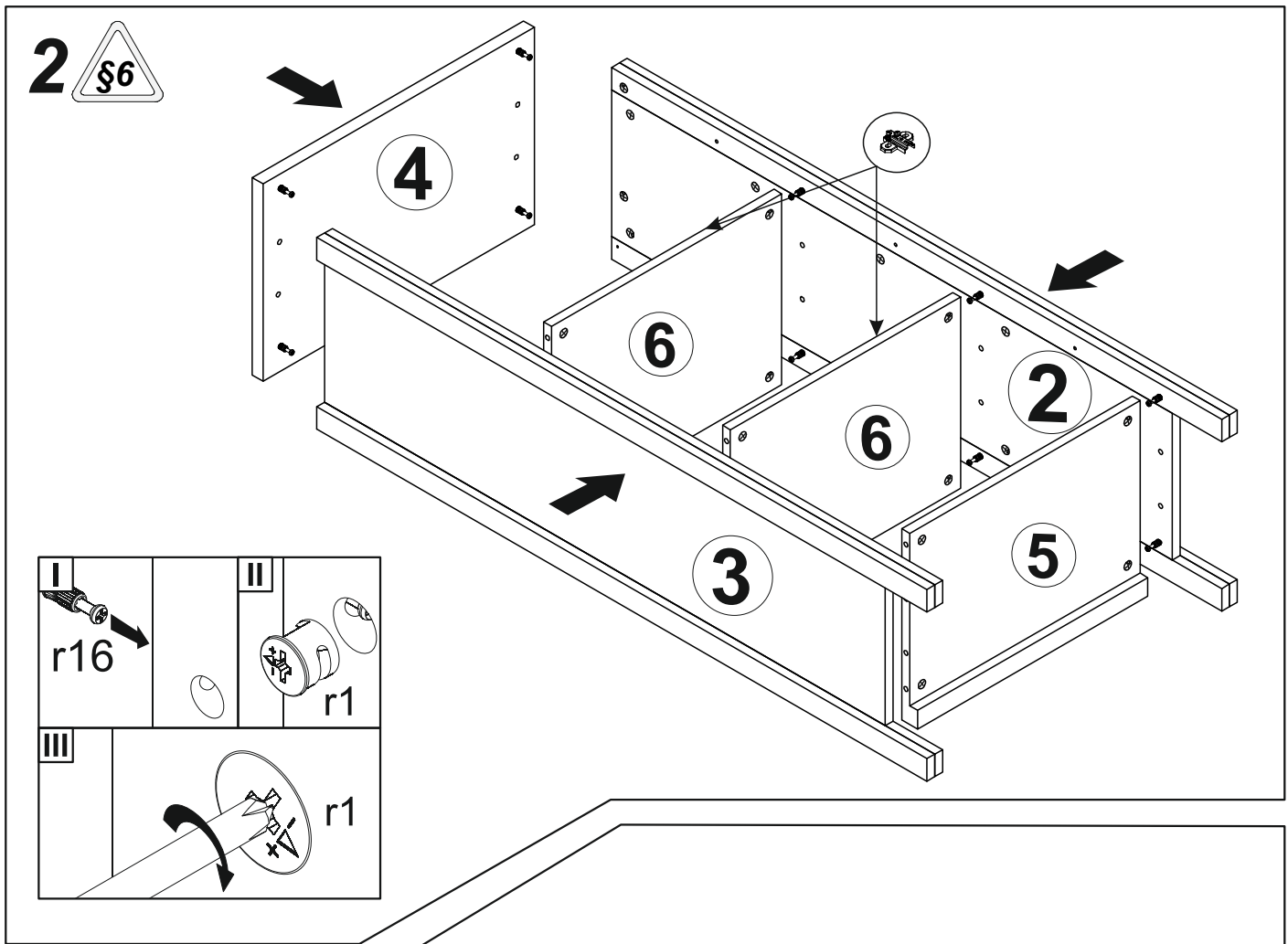

4

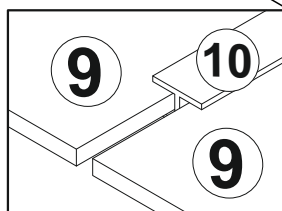
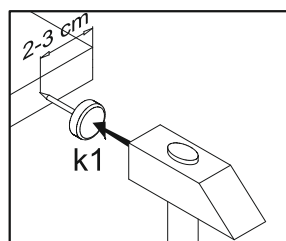
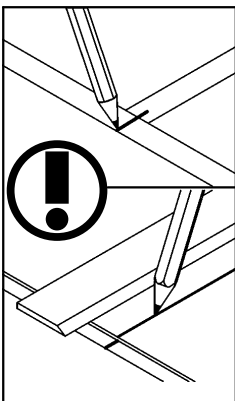
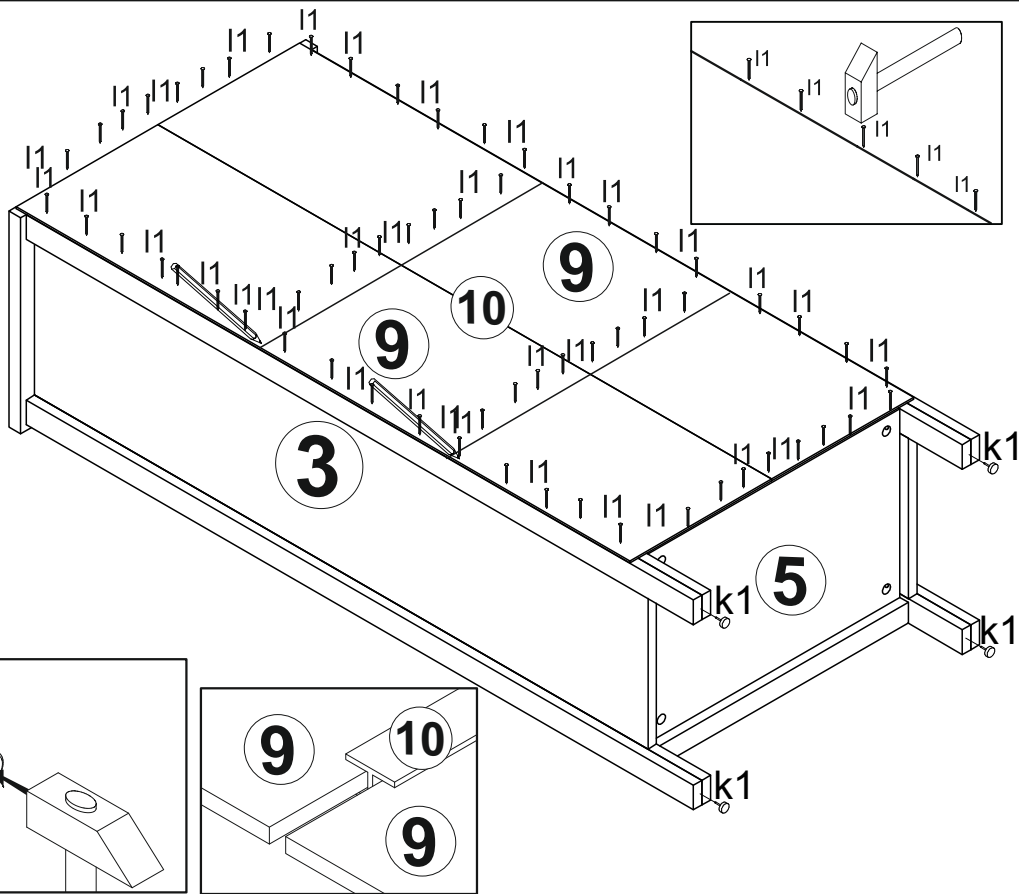
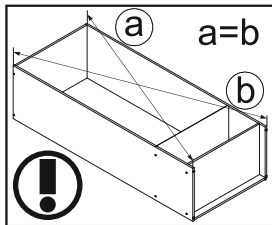

5

