





x2

**NR 1**

**B1**  8x28 x14

**K1**  Ø7x50mm x22

**W1**  x8

**W8**  x4

**C14**  
mm  8XIKMY03 x12

**C15**  
mm  8XAEMY03 x2

**C14**  
mm  8XAEMY03 x10

**J23**  x26

**G7**  x1

**NR 2**

**S6**  3,0x20 x11

**F1**  x2

**F7**  x2

**S2**  Ø3,0x13mm x2

**NR 3**

**Y2**  Kr8 x9

**D6**  H2 x9

**E3**  6,3x13 x18

**S8**  4x13 x18

**NR 4**

**R22** L-350 mm  x2L/2R

**E24**  6,0x11 x12

**S3**  3,5x13 x4

**P10**  3x13 x12

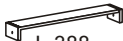
**F3**  L-388 x2

**T2**  5x32mm x4

**M2**  12x10mm x4

**P5**  4x30 x8

**NR 5**

**U45**  x4

**P5**  Ø4x30mm x8

**NR 6**

**F10**  x6

**P4**  Ø4x25mm x6

**NR 7**

**J11**  x2

**P13**  Ø3,5x13 mm x4

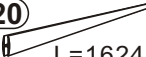
**J20**  L=1624 X1

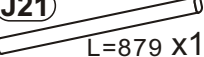
**J21**  L=879 X1



1

**B1** 8x28 x14

**D6** H2 x9

**S2** Ø3,0x13mm x2

**W1** x8

**E3** 6,3x13 x18

**W8** x4

**F7** x2

**R22** L-350 mm  
x2L/2R

**E24** 6,0x11 x12

**S3** 3,5x13 x4

**F10** x6

**P4** Ø4x25mm x6

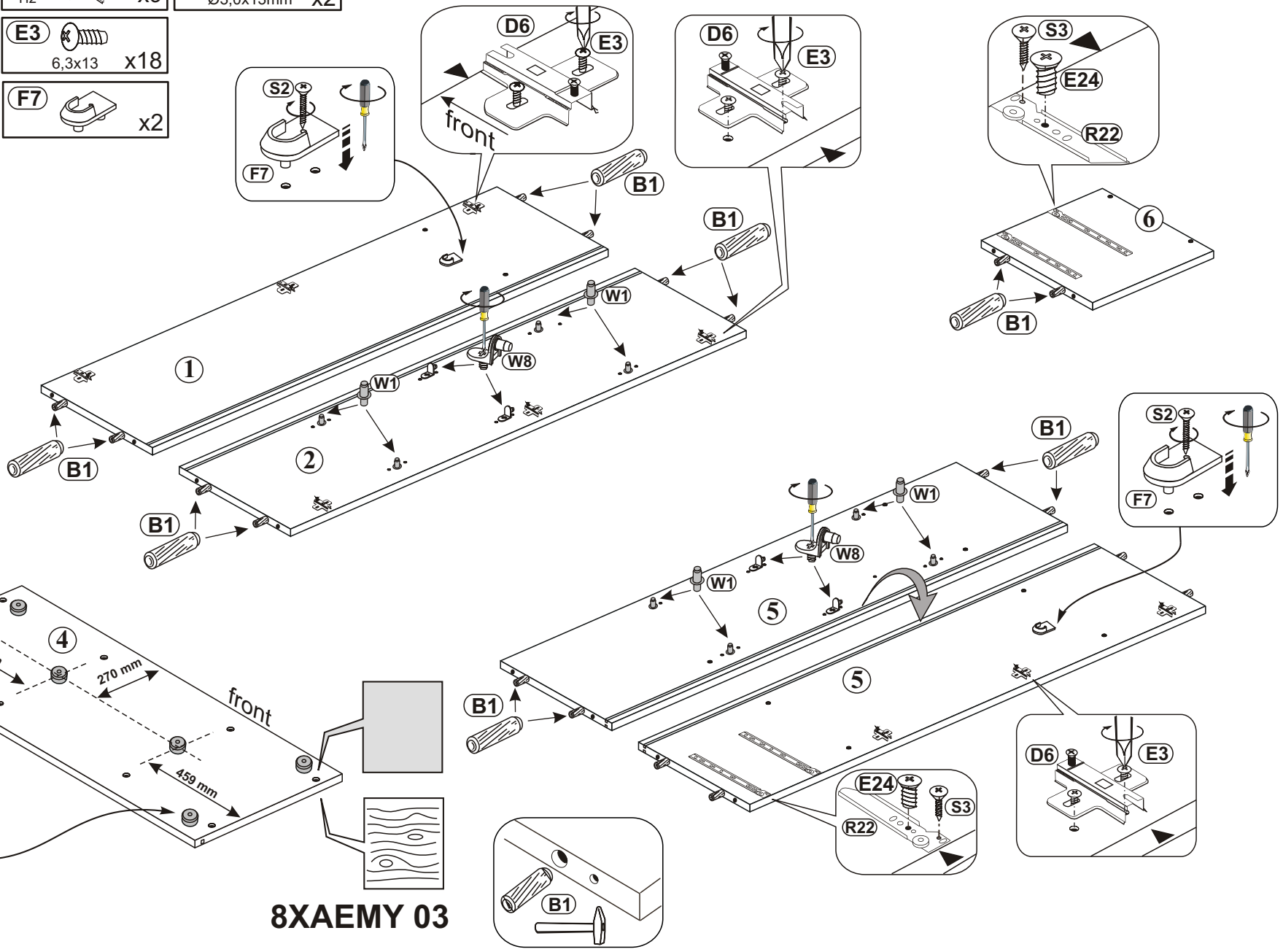

8XAEMY 03

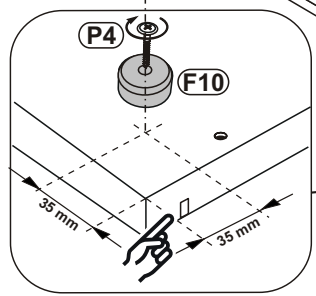

2

- R22** L-350 mm x2L/2R
- M2** 12x10mm x4
- P5** 4x30 x8
- P10** 3x13 x12
- F3** L-388 x2
- T2** 5x32mm x4

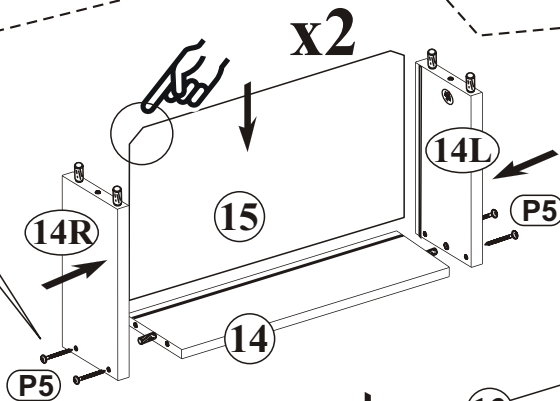
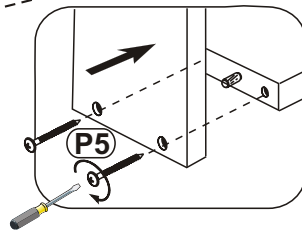
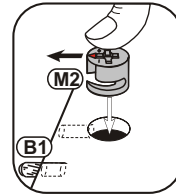
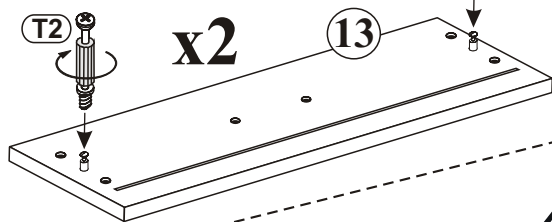
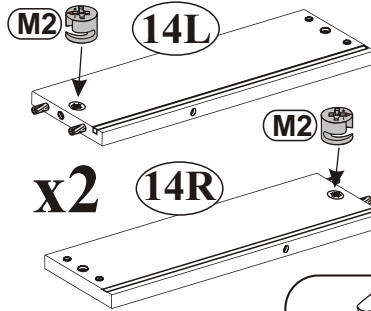
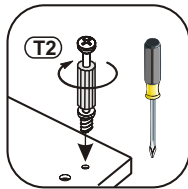

x2

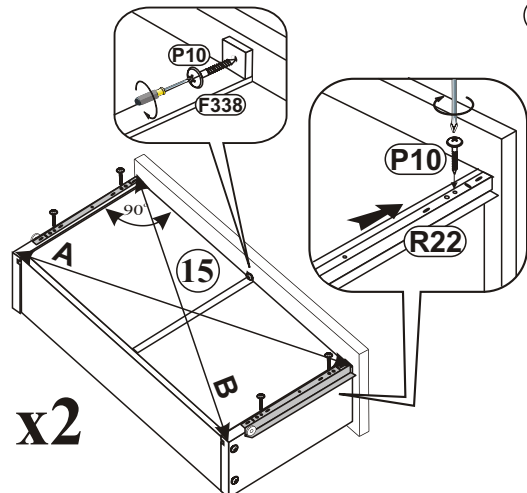
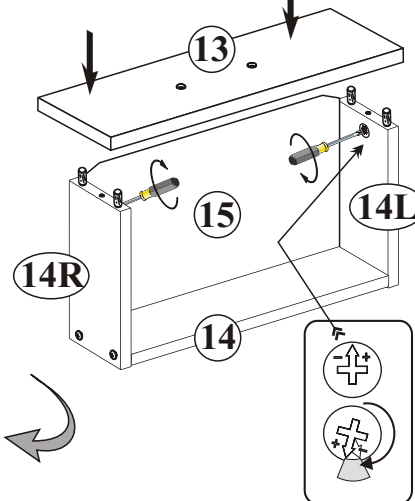

3

- K1** Ø7x50mm x4
- G7** x1

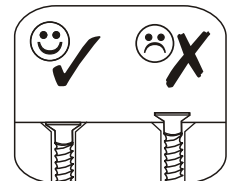
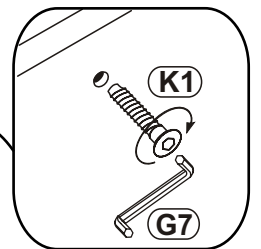
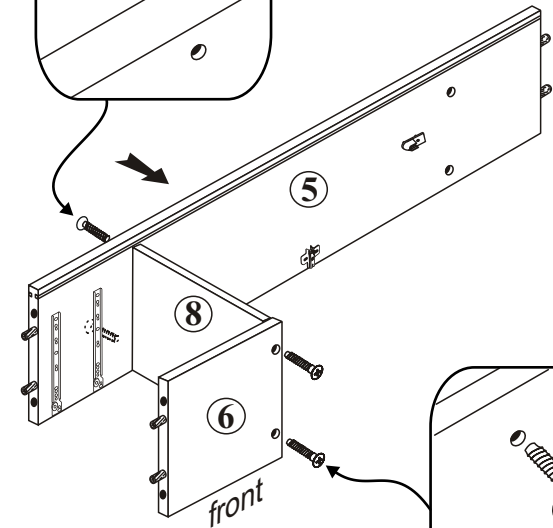
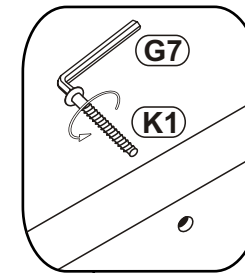

4

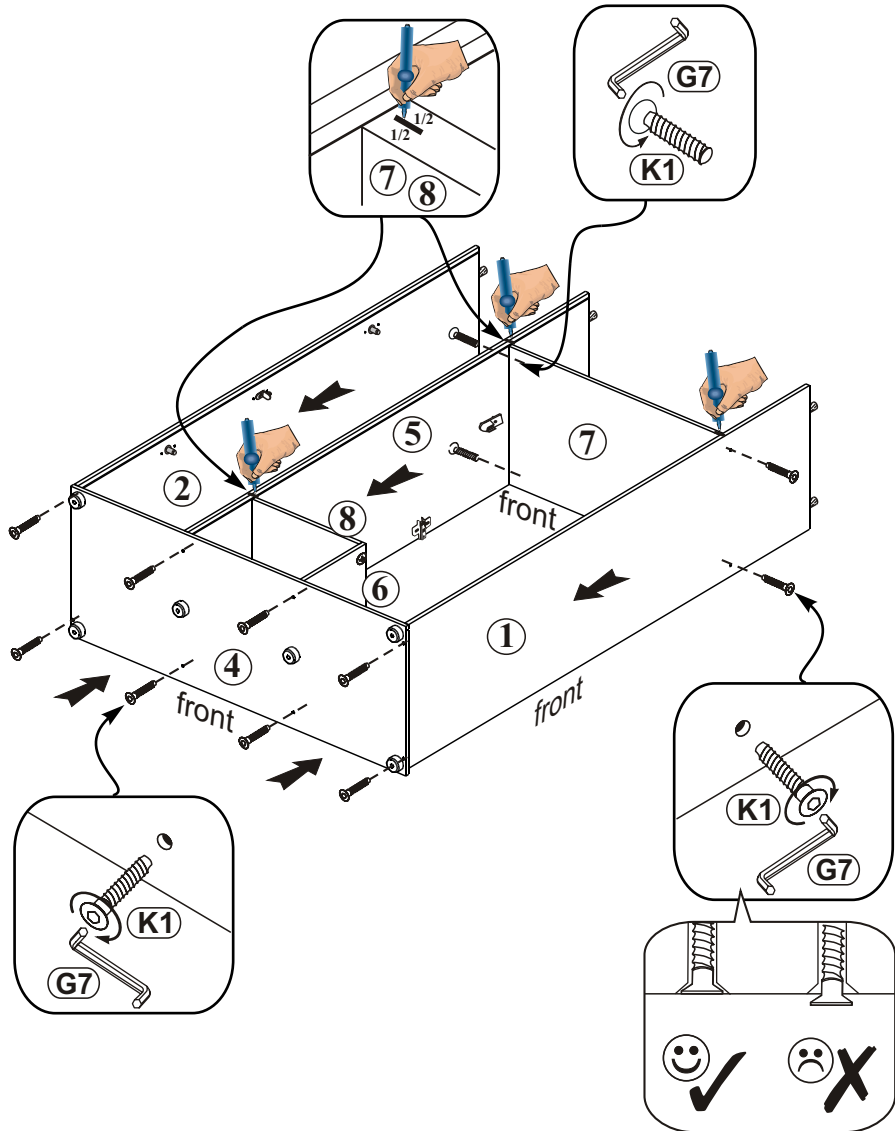
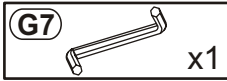
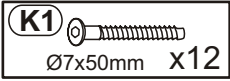

5

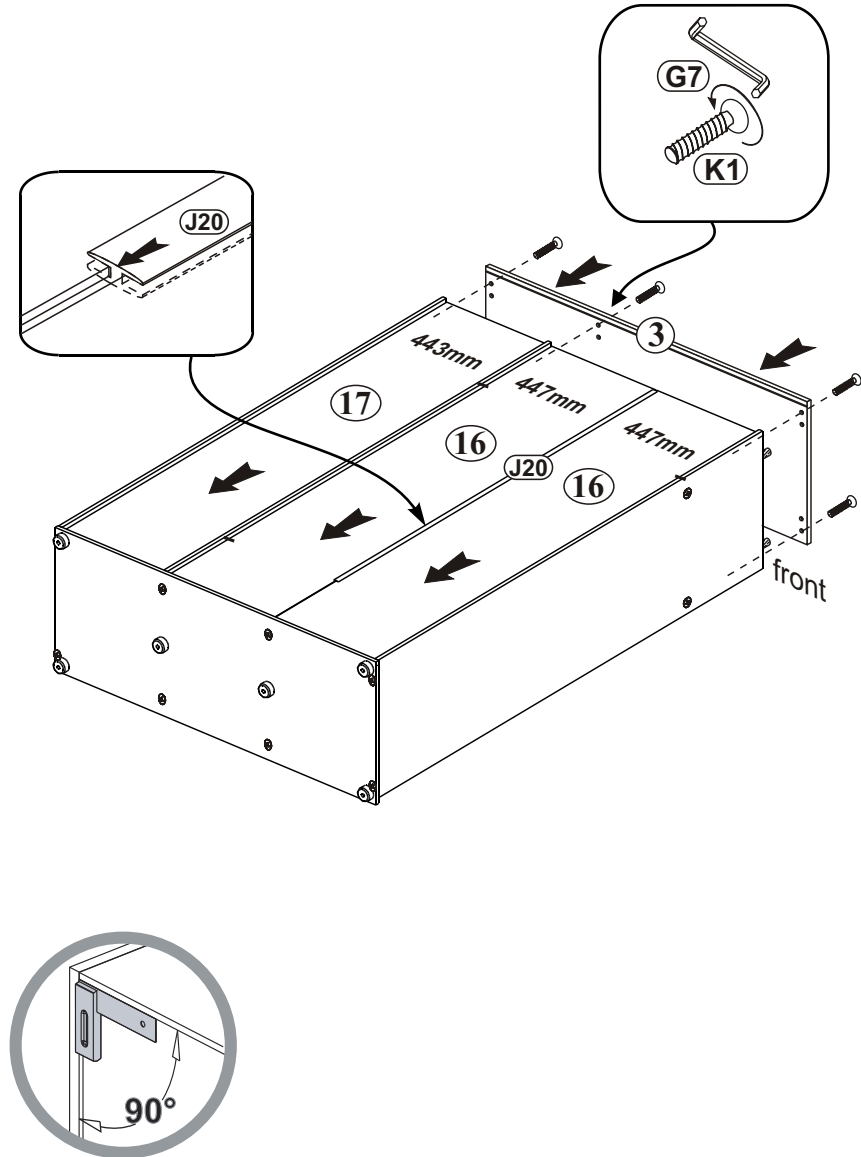
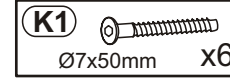

6

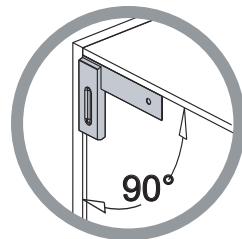
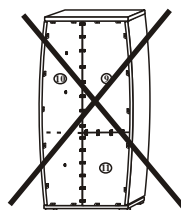
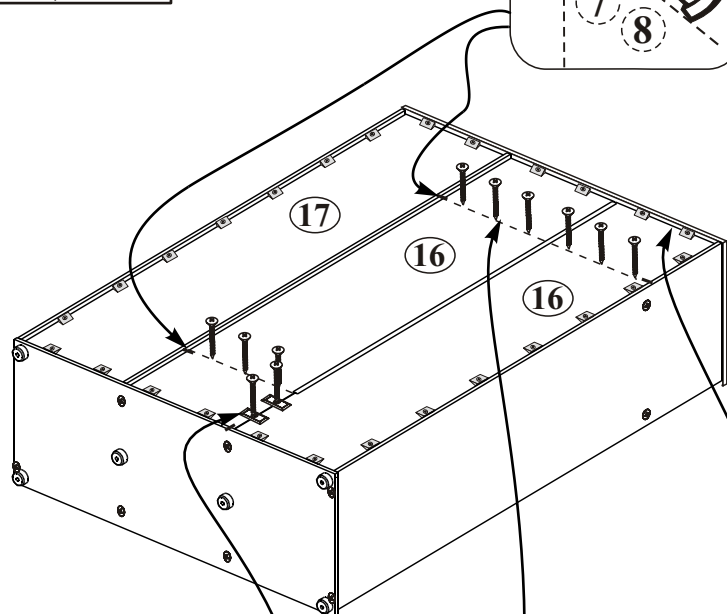
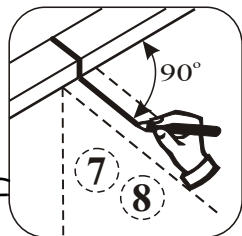
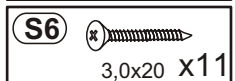
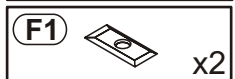

1

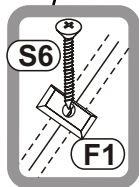

2

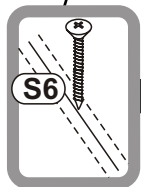

3

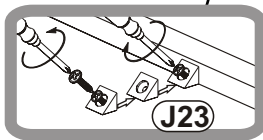

4

7

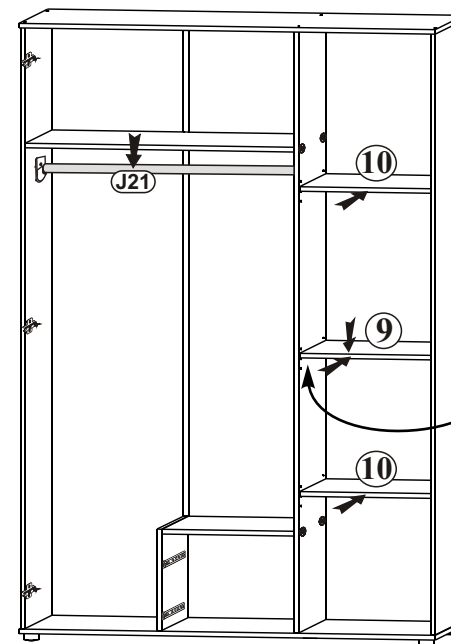
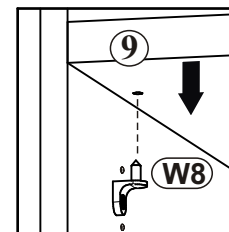
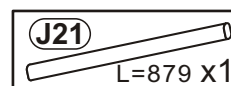

8

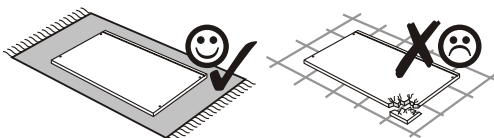
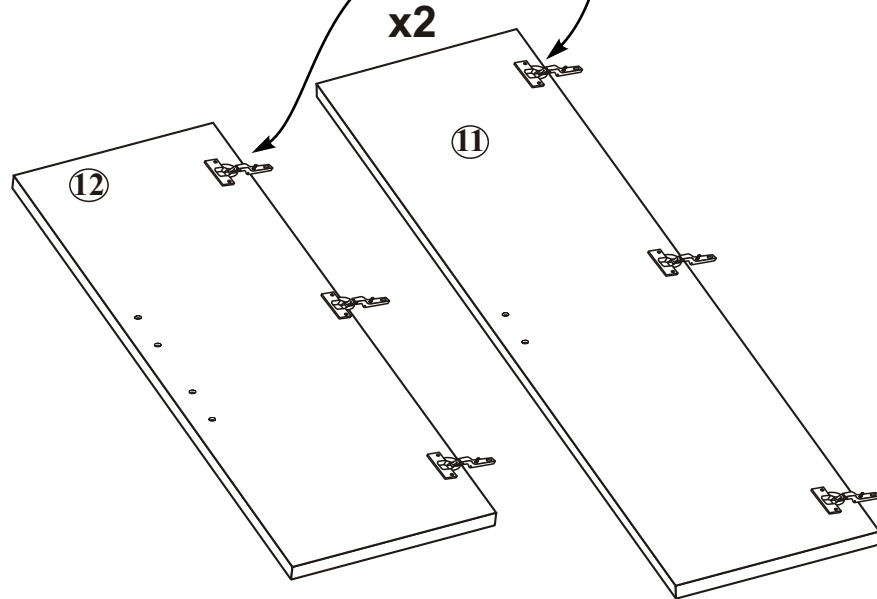
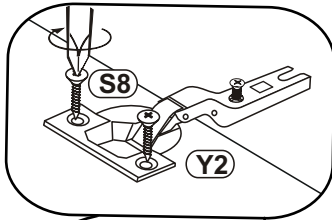
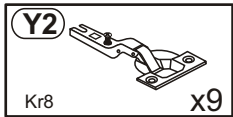

9

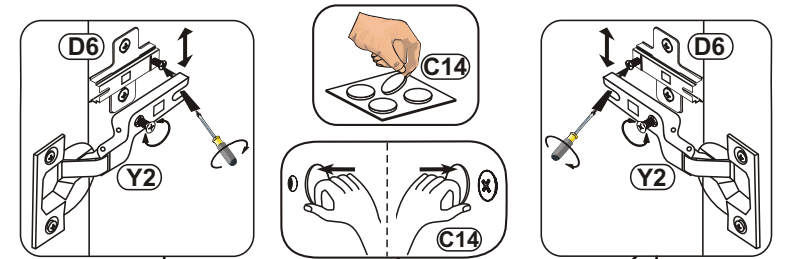
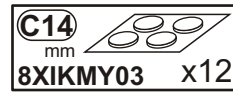
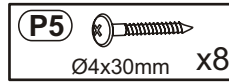
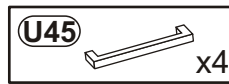

8XIKMY03 C14  
8XAEMY03 C15

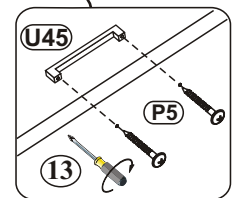
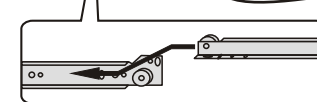
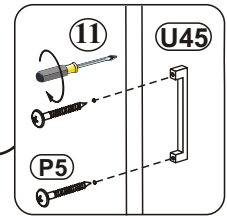
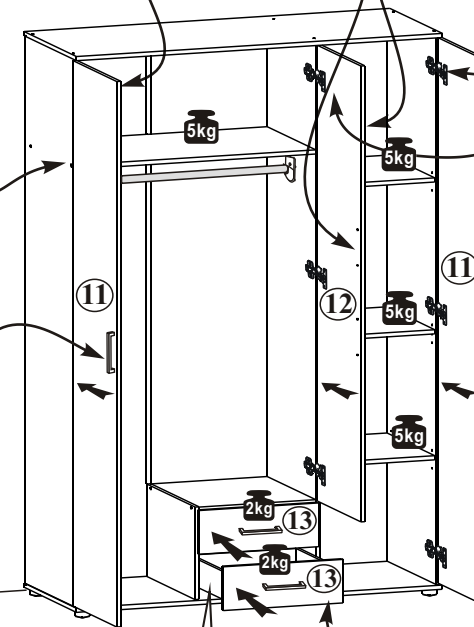
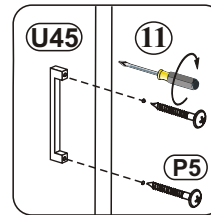
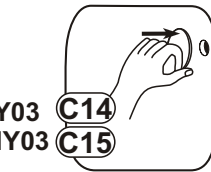



10

